



**ORLIMAN**<sup>®</sup>

*Advancing for your well-being*

## ORTHOPEDIC PRODUCTS

· TRAUMATOLOGY · RHEUMATOLOGY · REHABILITATION ·  
· SPORT MEDICINE · ORTHOPEDICS ·



**ORLIMAN®**

*Advancing for your well-being*



## INTRODUCTION A COMPANY WITH HISTORY - MISSION

With over 70 years of experience in the field of orthopedics, Orliman undertakes the development and series production of orthopedic products, spearheading future recovery of mobility and rehabilitation, preventive healthcare and functional improvement.

This work is carried out through the development of comprehensive solutions in conjunction with users, doctors, physiotherapists, suppliers, orthopedic establishments and designers.

## VISION

Orliman's vision is to be an innovative company that leads the non-invasive orthopedics market in Spain, France and international markets, that continually seeks new ways of satisfying the needs of orthopedic establishments, the medical community and users, providing technology and functionality to its products. This is how successful projects such as Orliman Sport and Orliman Pediatric were developed.





## PRODUCTS RANGE

Our range includes:

- Orthosis for lower limbs
- Orthosis for the trunk
- Orthosis for upper limbs
- Thermo-compressor orthosis
- Insoles and heelcups
- Podiatry
- Prosthesis



## WE ARE INCREASING OUR SPACE

We are multiplying our premises with a new headquarters of over 10,000 m<sup>2</sup> which contains all of the technological and professional means that a leading company requires.



## WORKFORCE

The workforce at Orliman is made up of professionals within each speciality who receive continuous training to ensure they are suitably informed about products and technological and medical advances, who strive to better themselves on a daily basis in order to attend to the needs of our customers.

In this way, not only do we extend our range of products, but we also achieve optimum results in their qualities, purposes and therapeutic effects, increasing their performance for the end user.



## INTERNATIONAL PRESENCE

An important part of Orliman's business is export, which began intensely and has continued in the same way over the last years. The results obtained in recent years have been excellent thanks to the good value for money ratio of our products and a well defined sales policy that suitably covers the needs of each market.

Orliman is present in the five continents.



## CERTIFIED

Orliman guarantees that most all your products are certified to the Oeko-tex standard 100 which proves the absence of substances that are hazardous and/or toxic to human health.

The products described in this catalogue are available at the best surgical aids shops in your town or city and conform to the Royal Decree 1591/2009 (Council Directive 93/42/EE).

The aforementioned products have been subjected to risk analysis in accordance with UNE-EN ISO 14971 and all the existing risks have been minimised.

All trials and tests have been carried out in accordance with the European norm, UNE-EN 22523 for prostheses and orthosis.

The company is certified with ISO 13485.



ASQUAL



## COMMUNICATION AND INTERNET

Due to the demand for information of our customers and professionals, Orliman, apart from the catalogues and brochures, has developed different tools over the last few years.

Another of our tools is our website which is continually updated and where customers can read news, see new products, place orders, consult scientific articles related to orthopaedics, etc.

We periodically issue electronic bulletins to keep customers punctually informed about new products, news related to the sector, promotions, etc. Our on-line product catalogue (multi-language), divided into parts of the body, will help you find what you are looking for through a search engine by references, pathologies, family, etc.

Well, that's all it takes, if you want to be punctually informed, subscribe completely free to the magazine or the electronic bulletin by contacting us by: Telephone, fax, e-mail Visiting our website.

▸ Sign up through our website or social network link.



<http://www.facebook.com/OrlimanOp>



<http://www.youtube.com/user/OrlimanOp>



[https://twitter.com/orliman\\_op](https://twitter.com/orliman_op)



[www.orliman.com](http://www.orliman.com)



## HEAD/NECK ORTHOTICS

- 10 **Cranial protection helmet**
- 10 **Cervical collars**
- 12 **Cervical collar with or without thoracic support**

## UPPER LIMBS ORTHOTICS

- 16 **Immobilizers** »Clavicle & Shoulder Immobilizers
- 18 **Abduction Arm Sling**
- 19 **Positioning Orthoses**
- 19 **Humertec®** »Elbow Orthoses
- 20 **Thermoplastic Orthoses**
- 21 **Elbowlution®** »Elbow brace
- 22 **Humerus Brace**
- 23 **Neuro-Conex®** »Shoulder support with forearm cuff
- 24 **Epitec® Fix** »Epicondylitis Armband
- 25 **Epitec®** »Epicondylitis Armband
- 25 **Codisil®** »Elbow Orthosis
- 25 **Elbow immobiliser** »Elbow Orthosis
- 26 **Manutec®** »Wrist Supports
- 31 **Manutec® Fix** »Bilateral Wrist Support
- 32 **Manutec® Fix Rizart** »Bilateral Wrist Support
- 33 **Manutec® Fix Rizart Plus** »Thermoplastic Wrist Support & Splints
- 33 **Wrist support braces**
- 34 **Manutec®** »Thermoplastic Wrist Support & Splints
- 35 **Finger immobilising glove splint**
- 35 **Stack Splints**
- 36 **Immobilising Frog Finger Splint In Malleable Aluminium**
- 36 **Thermoplastic Splints**
- 38 **Malleable aluminium hand brace**
- 39 **Dynamic upper limb orthoses**

## TRUNK ORTHOTICS / HARNESS

- 43 **Back Support Belts**
- 47 **Stomamed®** »Abdominal Supports For Ostomy Patients
- 48 **Dorsal Supports**
- 50 **Lumbitron® Elite** »Lumbosacral Back Supports
- 51 **Lumbitron® Elite Duo** »Lumbosacral Back Supports
- 52 **Lumbisil®** »Lumbosacral Back Supports
- 53 **Lumbitron®** »Lumbosacral & Lumbodorsal Back Supports
- 56 **3-Tex® Lumbo** »Semirigid Lumbosacral & Lumbodorsal Back Supports
- 57 **Lumbitec®** »Semi-rigid Back Supports
- 58 **Evotec®** »Semi-rigid Back Supports
- 59 **Dorso Evotec®** »Semi-rigid Dorso lumbar Back Supports
- 59 **Evotec® Forte** »Thermoplastic Module
- 60 **Dorsotech®** »Dorsolumbar brace
- 62 **Sacroiliac belt** »Sacroiliac Back Supports
- 63 **Trusses**
- 64 **Containment truss**
- 65 **Jewett STERNOTECH®**
- 67 **Jewett hyper-extension frame**
- 68 **Star Brace®** »Lumbosacral & Thoracic Lumbosacral Rigid Corsets
- 69 **Star Brace® Dynamic** »Lumbosacral Orthosis
- 70 **Star Brace® Dynamic Fix** »Lumbosacral Orthosis
- 71 **Knight Corset** »Lumbosacral Orthosis
- 72 **Modular dorso-lumbar Taylor orthosis** »Lumbosacral Orthosis
- 73 **Twin Shell Corset**
- 74 **Arnetec®** »Restraining Harnesses

## ORLIMAN® BRANDS



## LOWER LIMBS ORTHOTICS

- 81 **Hip Stabilizing Orthosis**
- 82 **Rodisil**® ▶Active Knee Supports
- 83 **Rodisil**® Plus ▶Active Knee Supports
- 84 **Pad-Fix**® ▶Patellar Knee Band
- 85 **3-Tex**® /// *advance* ▶Functional three-layer orthoses
- 89 **Gonartec**® ▶OA / Varo-valgo knee support for gonarthrosis
- 90 **Gonartec**® Plus ▶OA / Varo-valgo knee support for gonarthrosis
- 91 **Gonartec**® Advance ▶ Knee orthosis for the osteoarthritis treatment
- 92 **Knee Immobilizers & Orthoses**
- 95 **GCA** ▶Functional Knee Orthosis
- 98 **Thigh support / Calf support**
- 99 **Ankle Orthoses**
- 100 **Tobisil**® ▶Ankle Orthosis
- 100 **Tobiplus**® ▶Ankle Orthosis
- 101 **Achillosil**® ▶Elastic ankle brace
- 102 **Alttex**® ▶Ankle Orthosis
- 102 **Valfeet**® AIR ▶Air Inflatable Ankle Stabilising Orthosis
- 103 **Valtec**® ▶Ankle Stabilising Orthosis
- 103 **Plantar Fasciitis Orthosis**
- 104 **Leaf spring orthosis**
- 104 **Ankle Control Orthosis**
- 105 **Boxia**® ▶A.F.O. Drop Foot
- 107 **Boxia**® Plus ▶A.F.O. Drop Foot
- 108 **Walkers by Orliman**® ▶Ankle Immobilization Orthoses
- 111  **PROSTHESIS** ▶Silicone liners for tibial prostheses

## THERA GO® / SPORT / FIXQUICK / NEOPRENE / ONEPLUS / ELASTIC

- 145  ▶Functional therapeutic orthotics
- 149  ▶Elastic Supports
- 154  ▶Semi-rigid orthosis line with BOA® closure
- 157  ▶Thermo-compression Orthoses
- 167  ▶Thermo-compression Orthoses
- 169  ▶Orthoses for people with specific needs
- 175  ▶Elastic Line

## PEDIATRIC / MATERNITY

- 179  ▶pediatric
- 190  ▶Maternity range

## SITLIVE

- 195  ▶Anti-bedsore line
- 202  ▶Incontinence line
- 203  ▶Rest range
- 206  ▶Hygienic testers

## ADVERTISING MATERIAL

- 208 **Advertising Material**

## FOOT ORTHOTICS / INSOLES

- 116 **SOFY-PLANT** ▶Silicone Insoles & Heel Cups
- 119 **SOFY-PLANT** *fine* ▶Silicone Insoles & Heel Cups
- 119 **SOFY-PLANT** *fine Lady* ▶Silicone Insoles & Heel Cups
- 120  **by Biontech** ▶Insoles
- 121  **FeetPAD** ▶Insoles
- 122 **SOFY-PLANT** *gel* ▶Podology
- 128 **SOFY-PLANT** *mini* ▶Podology
- 128 **SOFY-PLANT** **Minifix** ▶Self-adhesive Podology
- 128 **SOFY-PLANT** **Miniplus** ▶Self-adhesive Podology
- 129 **SOFY-PLANT** ▶Self-adhesive Podology
- 130 **Hallux-Valgus** ▶Correctors
- 131 **Postoperative shoe**
- 132 **Special insole for diabetic foot and ulcerations**
- 133  **SPORT** ▶Technical Socks
- 134  **FeetPAD** ▶Technical Socks
- 137  **FeetPAD** ▶Therapeutic Shoes





## FUNCTIONAL ASSESSMENT CRITERIA FOR ORLIMAN PRODUCTS

The main functions of orthopaedic products and devices are fastening, compression, stabilisation and immobilisation.

The degree to which the materials, components and closure and adjustment systems used in their design fulfil these functions can be expressed on a scale of 0 to 5.

A definition of the characteristics of each function is provided below:

### ▶ FASTENING

The ability to join one element to another (device-patient) and prevent release.

### ▶ COMPRESSION

Volume reduction by means of pressure. The ability of the orthosis to apply external forces to a part of the patient's body.

### ▶ STABILISATION

A material's capacity to remain stable or revert to a position after becoming distorted. The ability of a device to keep an area of the patient's body in a desired position.

### ▶ IMMOBILISATION

The ability to reduce or restrict movement and keep it firm and constant. Reduction or restriction of any movement in a particular anatomical area.

## ASSESSMENT

### Fastening

- Absence of any system that produces specific fastening.
- Basic fastening systems by means of velcro or similar.
- Moderate fastening systems by means of velcro, straps or fasteners.
- Advanced fastening systems by means of straps with buckles or similar.
- Fastening and secure closure systems by means of buckles, magnets or similar.

### Compression

- Absence of any type of compression.
- Made with low compression materials without tension adjustment systems.
- Made with moderate compression materials including compression adjustment systems and flexible support elements.
- Made with high compression materials including compression adjustment systems and rigid support elements.
- Made with high compression materials including mechanical and/or pneumatic compression adjustment systems and rigid thermoplastic support elements.

### Stabilisation

- Absence of positioning elements to provide some degree of stabilisation.
- Basic stabilisation through its design and complementary elements.
- Good stabilisation in certain locations through its design, stabilising elements, stays, etc.
- Optimum stabilisation through its design, materials and support systems.
- Maximum immobilisation in all anatomical locations through its design, rigid structures and active components.

### Immobilization

- Absence of any elements that produce immobilisation.
- Slight restriction in the degree of mobility through product design.
- Good restriction in mobility in some locations through its design and the presence of components to fulfil that purpose.
- Optimum immobilisation in some locations through its design and the presence of mechanisms to partially restrict the mobility range.
- Maximum immobilisation in some or all anatomical locations through its design and the presence of mechanical elements to partially or totally restrict joint movement.



# Cranial protection helmet

Sin  
LATEX  
free



Ref.: H100 | Ref.: H101 | Ref.: H102

F .. C . S . I .

## CRANIAL PROTECTION HELMET

PERIMETER CM	
46	<p>CIRCUMFERENCE OF THE HEAD JUST ABOVE THE EARS</p>
48	
50	
52	
54	
56	
58	Ref.: H101 and H102 are children's models available in sizes 46 to 52.
60	

### Characteristics:

The lightweight helmet is made from breathable padded foam and has an interior terry lining and honeycomb fabric covering, providing great strength and durability. Supplied with chin strap and adjustable closure.

### Indications:

- Patients with infant cerebral palsy.
- Haemophilia.
- Ataxia.
- Spasticity and in all cases where there is a risk of cranial contusions

### Colours:

Ref.: H101: ■ Green.  
Ref.: H100: ■ Black.  
Ref.: H102: ■ Pink.



# Cervical collars

Sin  
LATEX  
free



F .. C . S . I .

Ref.: CC2108 (7,5 cm) | Ref.: CC2109 (9,5 cm) | Ref.: CC2111 (10,5 cm)

## SOFT COLLAR IN POLYURETHANE FOAM

PERIMETER CM	1	2	3	4	HEIGHT
CC2108	30-34	35-39	40-44	45-50	7,5
CC2109	30-34	35-39	40-44	45-50	9,5
CC2111	30-34	35-39	40-44	45-50	10,5



### Characteristics:

Made from 7,5-10,5 cm-wide polyurethane foam, rear velcro closure, anatomical design, grey colour. 100% cotton.

### Indications:

- Minor trauma of bony (spinous and transverse processes) and soft parts (whiplash).
- Postoperative care, torticollis, cervicalgia, cervicobrachialgia, compression syndromes, rheumatic and/or degenerative disorders.

Colour: ■ Blue.



F .. C . S . I .

Ref.: CC2208 (7,5 cm) | Ref.: CC2209 (9,5 cm) | Ref.: CC2211 (10,5 cm)

## SEMI-RIGID COLLAR IN POLYURETHANE FOAM WITH POLYETHYLENE REINFORCEMENT

PERIMETER CM	1	2	3	4	HEIGHT
CC2208	30-34	35-39	40-44		7,5
CC2209	30-34	35-39	40-44	45-50	9,5
CC2211	30-34	35-39	40-44	45-50	10,5

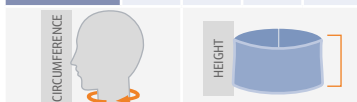

### Characteristics:

Made from 7,5-10,5 cm-wide polyurethane foam, polyethylene reinforcement band, rear velcro closure, anatomical design, washable grey coloured cover. 100% cotton.

### Indications:

- Minor trauma of bony (spinous and transverse processes) and soft parts (whiplash).
- Postoperative care, torticollis, cervicalgia, cervicobrachialgia, compression syndromes, rheumatic and/or degenerative disorders.

Colour: ■ Blue.

**Ref: CC2300**
F .. C .. S .. I ..

**SEMI-RIGID COLLAR (adjustable)**

SIZES	PERIMETER CM	HEIGHT
1	30-35	Min. 10 cm Max. 14 cm
2	35-40	
3	40-45	

**Characteristics:**

Made from two overlapping polyethylene pieces, height-adjustable by means of a Velcro binding, padded on its upper and lower edges, lined with imitation leather, rear Velcro closure system.

**Indications:**

- Minor trauma of bony (spinous and transverse processes) and soft parts (whiplash).
- Postoperative care, torticollis, cervicalgia, cervicobrachialgia, compression syndromes, rheumatic and/or degenerative disorders.

**Colour:**  White.

**Ref: CC2400**
F .. C .. S .. I ..

**SEMI-RIGID COLLAR WITH CHIN SUPPORT (adjustable)**

SIZES	PERIMETER CM
1	30-35
2	35-40
3	40-45

HEIGHT	
Front of	Min. 15 cm - Max. 20 cm
Back	Min. 7 cm - Max. 12 cm

**Characteristics:**

Made from two overlapping polyethylene pieces, height-adjustable by means of a Velcro binding, the upper piece is designed to accommodate the chin and distribute pressure over its entire surface for optimum comfort. Padded on its upper and lower edges, lined with imitation leather, rear Velcro closure system.

**Indications:**

- Minor trauma of bony (spinous and transverse processes) and soft parts (whiplash).
- Postoperative care, torticollis, cervicalgia, cervicobrachialgia, compression syndromes, rheumatic and/or degenerative disorders.

**Colour:**  White.

**Ref: CC2503**
**Ref: CC2504**

(8,3 cm)

(10,8 cm)

F ... C .. S ... I ...

**PHILADELPHIA PLASTAZOTE COLLAR**

PERIMETER CM	1	2	3	HEIGHT
CC2503	33-41	41-46	46-48	8,3
CC2504	33-41	41-46	46-48	10,8

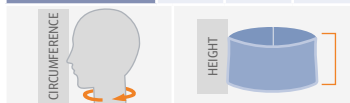
**Characteristics:**

Orthosis comprising of front and back pieces, made from plastazote with rigid thermoplastic supports and Velcro strap closures on the sides. Its upper part is designed to make full contact with the lower part of the head by means of an occipital-chin support. Its lower part rests laterally on the shoulders with the front portion situated over the sternum and the rear over the D5 vertebra. The front part of the collar features a tracheal opening.

It is possible to perform X-rays while the patient is wearing the device, as it contains plastic rivets that do not distort.

**Indications:**

- Severe trauma with vertebral fractures, postoperative protection (laminectomy), metastasis and, especially, upper cervical injuries (C1-C2).

**Colour:**  Beige.

**ACCESORIES**

**Ref.: CC2700**
F ... C .. S ... I ...

**THORACIC SUPPORT EXTENSION FOR OCCIPITAL MANDIBULAR IMMOBILISATION**

SIZES	PERIMETER CM	BELOW CHEST
ONE SIZE	min. 75 cm max. 125cm	

**Characteristics:**

- Thoracic extension valid models for joining CC2503, CC2504 and CC2600.

**Colour:**  Grey.

# Cervical collar with or without thoracic support



Ref.: CC2600

F ... C .. S ... I ...

## TWO-PIECE CERVICAL COLLAR. RIGID CERVICAL ORTHOSIS WITH OCCIPITAL-MANDIBULAR SUPPORT

SIZES	PERIMETER CM
1	30-35
2	35-40
3	40-45



### Characteristics:

Made from low-density polyethylene, comprised of two pieces joined together by lateral Velcro closures. The orthosis has a padded foam inner lining and outer velour covering for an increased feeling of comfort and to prevent chafing. The front part of the collar features an opening for users with tracheotomy. X-rays can be carried out with the patient wearing the collar and the fabric elements can be removed for washing.

### Indications:

- Post-traumatic immobilisation (whiplash).
- Treatment of cervical disc herniation.
- Post-operative protection.

Colour:  Grey.



Height:

Min. 8 cm - Max. 11 cm



Both the occipital and mandibular supports can be adapted to the physical characteristics of each patient by loosening the buttons on the sides of the orthosis, thereby preventing the appearance of points of excessive pressure.

## ACCESSORIES



Ref.: CC2700

F ... C .. S ... I ...

## THORACIC SUPPORT EXTENSION FOR OCCIPITAL MANDIBULAR IMMOBILISATION

SIZES	PERIMETER CM
ONE SIZE	min. 75 cm max. 125cm



### Characteristics:

- Thoracic extension valid models for joining CC2503, CC2504 and CC2600.

Colour:  Grey.



Ref.: CC2701

## KIT ALUMINIUM PLATES

SIZES	ONE SIZE

### Characteristics:

Aluminium plates for: CC2503 / CC2504 / CC2600 y corsés CT1001 / CT1002.

Colour:  Black.



Ref.: CC2800

F

...

C

...

S

...

I

...

## CERVICAL COLLAR WITH THORACIC SUPPORT

SIZES	PERIMETER CM
1	30-35
2	35-40
3	40-45

CIRCUMFERENCE

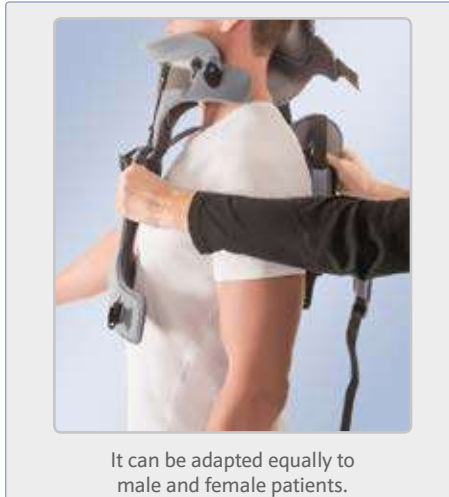

It can be adapted equally to male and female patients.

### Characteristics:

Everyday activities expose the cervical spine to complex stresses and strains, subjecting it to compression, flexion and torsion forces: therefore, to ensure correct immobilisation, it is essential to prevent flexion and extension movements, such as rotation and lateralisation, while, at the same time, releasing pressure on the intervertebral discs. The orthosis is made from low-density polyethylene and features a padded foam inner lining and outer velour covering for an increased feeling of comfort and to prevent chafing.

The fabric elements can be easily removed for washing to ensure proper hygiene. The materials used in its manufacture enable X-rays to be carried out.

If necessary, the upper element (comprising of a Miami J cervical orthosis) can be detached from the lower element and used separately for lighter treatment.

### Indications:

- Cervical spine injuries that require immobilisation of segments C1 to T1 during treatment.
- Post-operative protection.
- Bone metastasis.

### Colour:

■ Grey.

### Observations:

Unisex design.









## ANATOMIC ASPECTS

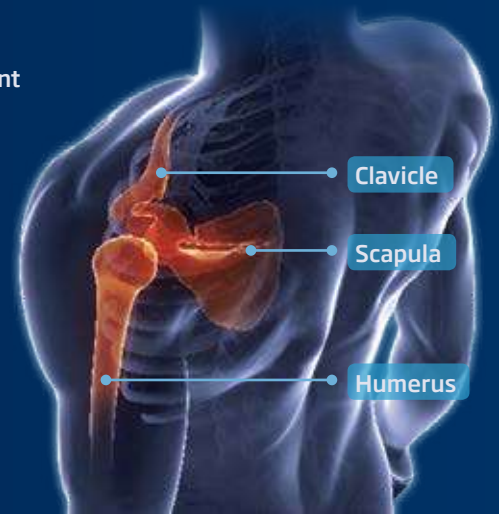
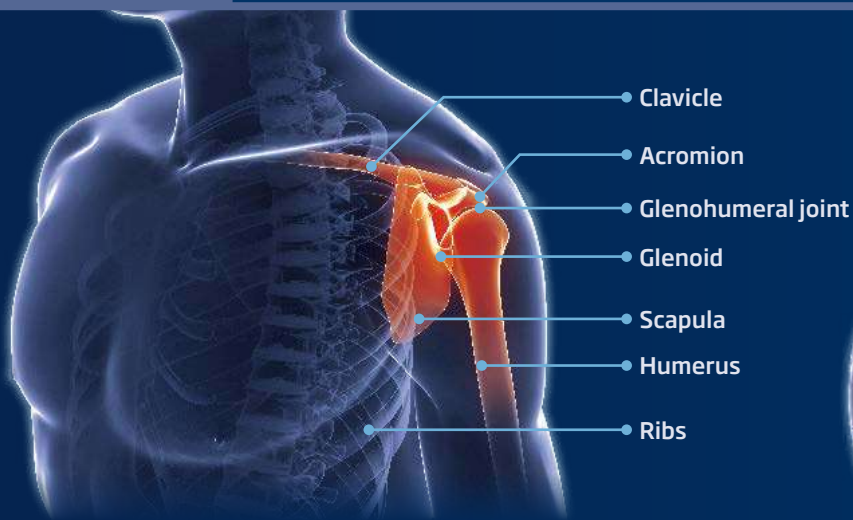

F Fastening C Compression S Stabilisation I Immobilization

## Immobilizers >Clavicle & Shoulder Immobilizers



Ref.: IC-30

F ... C ... S ... I ...

### CLAVICLE STRAP

SIZES	TORAX
0 (children)	55-65
1	65-80
2	>80



#### Characteristics:

The clavicle splint IC- 30, introduces significant design improvements for better adjustment and increased comfort. The first important point is the new design of the acromion clavicle pad, specifically designed to exert extensive and comfortable pressure on the acromion and humeral head in the deltopectoral area. The axillary area is constructed of microfibre on the inside which produces highquality padding and in turn allows proper ventilation.

#### Indications:

- Anatomic reminders.
- Stabilisation after injury or surgery.
- Retropulsion of the shoulders.

Colour: Beige.



Ref.: C-40

F . C . S . I .

### ARM SLING

SIZES	ONE SIZE



#### Characteristics:

Sling made from velour with terry cloth lining in bag form for the forearm and Velcro fasteners. Fastening bands allowing regulation of arm height and independent adjustable shoulder immobiliser band on the belt.

#### Indications:

- Subluxations of the shoulder.
- Mild shoulder injuries.
- Contains and stabilises the scapulohumeral articulation.

Colour: Beige.

Other Models: Ref.: C- 40N (child sling).





Ref.: C-41

F ... C .. S ... I ...

## SHOULDER & ARM IMMOBILIZER SLING



SIZES	
1	<38
2	>38

LENGTH IN CM OF FOREARM

### Characteristics:

Support made from velour with bibshape for the forearm, wrapping round it and fastening onto itself allowing height regulation. Extended with two bands on each side of the shoulders, which run over the back and fasten on the forearm with Velcro. It has an additional wide, 15cm, shoulder immobiliser band for subluxations or luxations of the scapulohumeral articulation and when strong immobilisation is required.

### Indications:

- Subluxations of the shoulder.
- Mild shoulder injuries.

Colour: ■ Beige.



Ref.: C-42A

Ref.: C-42B

F . C S . I .

## ARM SLING



SIZES	LENGTH CM
1	<30
2	36
3	>42

LENGTH IN CM OF FOREARM

### Characteristics:

Made with breathable honeycomb fabric in bag form for elbow and forearm. It has an adjustment band that allows regulation of arm height with neoprene shoulder protection cushion.

### Indications:

- Subluxations of the scapulo-humeral articulation. When relief of the shoulder joint is required.
- Contains and stabilises scapulo-humeral articulation.

### Colours:

- C-42A: ■ Blue.
- C-42B: ■ Beige.



C-42 Video

Can be combined with immobilizing shoulder strap  
Ref.: CINCHA-C42A Blue / Ref: CINCHA-C42B Skin



Ref.: C-43A

F . C S . I ..

## SHOULDER & ARM IMMOBILIZER SLING



SIZES	LENGTH CM
1	<30
2	36
3	>42

LENGTH IN CM OF FOREARM

### Characteristics:

Manufactured in breathable mesh fabric with pocket for the elbow and forearm. It has a Velcro strap to adjust arm height and a Velcro strap for elbow-body adjustment.

### Indications:

- Maintains shoulder-elbow joint in position, supports forearm.
- Prevents descent of humeral head.

Colour: ■ Blue.



Ref.: C-44

F ... C .. S ... I ...

## AMBIDEXTROUS VELPEAU SHOULDER IMMOBILISER



SIZES	CONTOUR OF THE TRUNK PLUS THE ARM
1	<95
2	95-110
3	>110

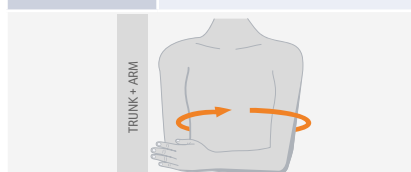

### Characteristics:

The Velpeau C-44 orthosis, is indicated in the conservative treatment of humerus neck fractures, is made of a single piece in the form of a harness, where an anatomically designed pad fits the affected shoulder above and is connected to material surrounding the affected forearm. It is manufactured in one piece of poromax-based fabric in a grid type arrangement.

### Indications:

- Immobilisation of dislocations of the acromioclavicular joint.
- Conservative treatment of humeral neck fractures.
- Non-displaced and non-joint scapula fractures, anterior shoulder dislocation.
- Conservative treatment of humeral head and lesser tuberosity, acute scapulo-humeral periarthritis.
- Immobilisation of the shoulder after the inflammatory phase.
- Rheumatism, rheumatoid polyarthritis.

Colour: ■ Black.

# Immobilizers

► Clavicle & Shoulder Immobilizers



Ref.: C-48

F • C S • I •

## ARM SLING



SIZES

ONE SIZE

**Characteristics:**

The arm sling consists of an antebrachial support attached to a strap that passes around the back of the neck. The inside of the antebrachial support is made from breathable honeycomb fabric and the outside is velour. The strap has a terrycloth interior and honeycomb exterior and is length adjustable by means of Velcro fasteners, enabling it to be adjusted to the physical characteristics of each patient. The strap is designed to adopt an anatomical shape, which helps to relieve discomfort from pressure at the back of the neck. The Orliman arm sling also has a Velcro fastener to enable the antebrachial support to be adjusted to the needs of each patient. The arm sling is manufactured in one size and can be used on the right or left arm.

**Indications:**

- Post-operative or post-traumatic immobilisation treatment.
- Arm and shoulder trauma injuries whose treatment requires reduction of mobility.
- Soft tissue injuries such as infections or burns.
- Rheumatic disorders.

**Colour:**  Grey.

## Abduction Arm Sling



Ref.: C-45

F ••• C • S ••• I •••

## ABDUCTOR SLING (15°/30°)

SIZES	LENGTH CM
1	<30
2	36
3	>42

LENGTH IN CM OF FOREARM

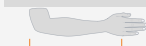
**Characteristics:**

Manufactured in breathable honeycomb fabric, which allows the free circulation of air to prevent possible irritation. Its design enables control of internal and external rotation, which can be limited by means of the anti-rotational strap. The opening in the front panel enables the patient to do elbow exercises. Hand exercise ball to maintain muscle tone in the hand and improve circulation. Foam abductor cushion with 15°/30° of abduction designed for the patient's maximum comfort.

**Indications:**

- As an orthopaedic positioning method for sprains, luxation, glenohumeral subluxation.
- Capsular displacement.
- As a conservative treatment for acute and chronic bursitis.
- Rotator cuff repair surgery.
- Shoulder endoprosthesis implantation.
- Adhesive capsulitis.
- Entrapment syndrome.
- After arthroscopic treatment of Bankart lesions.

**Colour:**  Blue.

Ambidextrous sling.



Hand exercise ball to maintain muscle tone and improve blood flow.



Cushions for 15° abduction. Both cushions can be joined for 30° abduction.



Ref.: C-46

F ••• C • S ••• I •••

## ABDUCTOR SLING (30°/45°)

SIZES

ONE SIZE

**Characteristics:**

Manufactured in breathable honeycomb fabric, it facilitates air circulation to prevent possible irritation. The arm support is made from Poromax® fabric to prevent sweating. On its inner surface, it has a hook closure to fasten it to the velour of the cushion.

**Indications:**

- As an orthopaedic positioning method for sprains, luxations and glenohumeral subluxations.
- Capsular displacement.
- As a conservative treatment for acute and chronic bursitis.
- In rotator cuff repair surgery.
- In shoulder endoprosthesis implantation.
- Adhesive capsulitis.
- Entrapment syndrome.
- As a method of immobilisation after implantation of a prosthetic shoulder joint and after acromioplasty.

**Colour:**  Blue.

Contralateral padded strap

Ambidextrous sling



Hand exercise ball to maintain muscle tone in the hand and improve circulation



Ref.: C-47

F . . . . C . . . . S . . . . I . . . .

## ORTHOSIS FOR POSITIONING AT 90° OF EXTERNAL ROTATION

SIZES	LENGTH CM
1	<30
2	36
3	>42

LENGTH IN CM OF FOREARM

### Characteristics:

Manufactured in breathable honeycomb fabric, it facilitates air circulation to prevent possible irritation. Its design allows a slight shoulder abduction angle of 15° and external rotation of 90°. Hand exercise ball to maintain muscle tone in the hand and improve circulation.

### Effets:

Immobilisation of the shoulder and arm at 90° of external rotation with shoulder abduction of 15° or 30°.

### Indications:

- As an orthopaedic positioning method for sprains, luxations and glenohumeral subluxations.
- Capsular displacement.
- In rotator cuff repair surgery.
- After arthroscopic treatment of Bankart lesions.
- Repair of soft tissue.

Colour: Blue.

## Humertec® ▶ Elbow Orthoses



F . . . . C . . . . S . . . . I . . . .

Ref.: 94300

Ref.: 94301D RIGHT

Ref.: 94301I LEFT

Ref.: 94302D RIGHT

Ref.: 94302I LEFT

FLEXION-EXTENSION CONTROL AND ELBOW ORTHESIS

FLEXION-EXTENSION CONTROL & ELBOW ORTHESIS WITH PALM SPLINT

FLEXION-EXTENSION CONTROL & ELBOW ORTHESIS WITH PALM-THUMB SPLINT

SIZES	A	B	PERIMETER OF WRIST C Only model references Ref.: 94301/94302
1	26-32	20-25	<18
2	32-37	25-30	18-22
3	37-43	30-35	>22

APPROXIMATE LENGTH  
(minimum 42, maximum 44 cm).

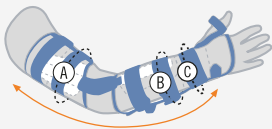

### Characteristics:

Made up of an arm valve and a forearm valve joined together via a mono-central articulation with the possibility of adjustment of the flexo-tension through 0° to 90° in intervals of 15°. Thermoplastic nucleus that provides support and rigidity. Bands adjust the double sided velour through the use of a buckle.

### Indications:

- Diaphysary fractures of the humerus, fractures of the middle to lower third of the humerus (supra-condylar).
- Fractures of the ulna and radius.
- Pathological fractures (osteolytic metastasis).
- In surgery of the elbow ligaments.
- With palmar splints: in case of neurapraxia (temporary paralysis), due to the traumatic agent, the use of this orthosis is recommended with a palmar support.
- In case of radial paralysis use with a palmar splint is recommended with abduction of the thumb.

Colour: Grey.

## ACCESSORIES



Ref.: Art-Alu-Pc-Neg/CODO

### MONOCENTRIC ELBOW JOINT

#### Characteristics:

The elbow joint can be adjusted in steps of 15°. This joint comes as standard in models:

- 94300
- 94301D / 94301I
- 94302D / 94302I
- TP-6300
- TP-6301D / TP-6301I

It can also be ordered separately.

SIZES	ONE SIZE	1 UNIT
-------	----------	--------

# Thermoplastic Orthoses



Ref.: TP-6300 **F** .... **C** .... **S** .... **I** .....

**ARTICULATED ELBOW ORTHOSIS, WITH ARM AND FOREARM IN THERMOPLASTIC**



Ref.: TP-6301D RIGHT

Ref.: TP-6301I LEFT

**ARTICULATED ELBOW BRACE, WITH ARM AND FOREARM AND HAND SUPPORT IN THERMOPLASTIC**

**Characteristics:**

Modular orthosis for the upper arm composed of a brace for the humerus, a brace for the forearm and hand support, elbow articulation with flex-extension adjustment and guide for correct size, adjustment straps and microhook fastening system. Can be cut to the desired length, linked with 1 mm polyethylene tabs, with additional shoulder strap. Internal plastazote padding.

**Indications:**

- Fractures of the humeral diaphysis, whether by direct or indirect trauma and pathological fractures.
- Surgical treatment of fractures, or fractures associated with paralysis.
- As an aid to the treatment of upper arm fractures associated with the elbow joint.
- Hand support indicated in cases where the fracture is associated with paralysis or as required (Ref.: TP-6301).

**Colour:**  White.

TP-6300	TP-6301	SIZES	HUMERUS		FOREARM		*
			PROXIMAL	DISTAL	PROXIMAL	DISTAL	
LENGTH	LENGTH		A	B	C	D	
35-47	35-57	1	25	22	22	19	±3
35-47	35-57	2	27	24	24	21	±3
35-50	35-60	3	30	27	27	24	±4
35-50	35-60	4	32	29	29	26	±4
35-50	35-60	5	34	31	29	26	±4

\*The range can vary in:

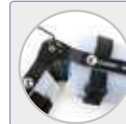
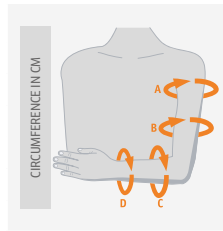

Monocentric joint with possibility of regulating the flexion-extension from 0° to 90° in intervals of 15°, as well as total lock.

**Movement control:**

Via the elbow joint with a flex-extension adjustment to limit the mobility of the elbow as desired. Protection given to the area of the fracture from external impact, rotational movements or other unwanted physical forces.



Ref.: TP-6400

**F** .... **C** .... **S** .... **I** .....

**HUMERUS BRACE IN THERMOPLASTIC**

LENGTH	SIZES	HUMERUS		*
		PROXIMAL	DISTAL	
		A	B	
29	1	25	22	±3
30,5	2	27	24	±3
32	3	30	27	±4
34	4	32	29	±4
34	5	34	31	±4

\*The range can vary in:

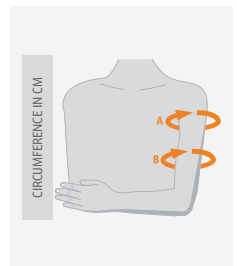

**Characteristics:**

Thermoshaped, two-piece humerus brace in low-density polyethylene, velour adjustment straps and microhook fastening system. Can be cut according to the desired length, coupled with 1 mm polyethylene tabs. Internal plastazote padding.

**Indications:**

- Diaphyseal fractures of the humerus.
- Post-surgical treatment of fractures and control of the instability of the fractured area during the healing process.

**Colour:**  White.

## MAIN FEATURES



Flexion-extension control.



Telescopic aluminium rods to adjust the height.



Ref.: 94305D  
RIGHT

Ref.: 94305I  
LEFT

F ... C ... S ... I ...

### TELESCOPING ROM ELBOW BRACE

#### SIZES

ONE SIZE

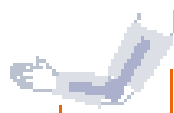

Min.: 37 cm  
Máx.: 46 cm



Extension limitation: from 0° to 90° (in increments of 15°).

Flexion limitation: from 0° to 120° (in increments of 15°).

#### Characteristics:

Elbow brace with unilateral monocentric joint consisting of 4 cuffs (2 arm and 2 forearm) for perfect range of motion control or immobilisation of the elbow.

It is highly adaptable thanks to the flexibility of its rigid cuffs, which ensure proper attachment to the arm and forearm, and it features telescopic length adjustment.

Contact with the limb is by means of pieces of soft foam which offer air permeability and ensure breathability.

It is lightweight and simple to handle, and, after the first fitting, quick and easy to apply and remove.

#### Effects:

- Range of motion control.
- Immobilisation.
- Post-operative maintenance of the joint in the correct position.
- Pain relief.
- Facilitates joint function recovery.

#### Indications:

- Grade 1 and 2 sprains.
- Dislocation.
- Distal fractures of the humerus or proximal fractures of the radius/ulna.
- Post-injury or post-operative rehabilitation.

Colour:  Black.

# Thermoplastic Orthoses



Ref.: TP-6500D RIGHT

Ref.: TP-6500I LEFT

F

C

S

I

## ANTEBRACHIAL FOREARM SPLINT IN THERMOPLASTIC

SIZES	A	DORSAL LENGTH CM	
1	20-24	28	
2	24-28	29	
3	28-32	30	
4	32-36	31	

### Characteristics:

Made of low density polyethylene composed of 2 valves joined together using velour straps and mini hooks. On the back it is extended along the hand to the metacarpophalangeal joint.

### Indications:

· Forearm and wrist fractures, post-operative.

■ **Colour:**  White.

# Humerus Brace



Ref.: TP-6401

Ref.: TP-6402

SHORT MODEL

F

C

S

I

## THERMOPLASTIC HUMERAL BRACE WITH FABRIC COVERING

### Characteristics:

Bi-valve thermoformable humeral orthosis in low-density polyethylene and covered with padded fabric. Breathable interior honeycomb lining. 2 thermoplastic pieces incorporated into the lining and joined by elasticated fabric. Adjustment by means of two velour straps with Velcro closure. Suspension and fastening system by means of a chest strap. The brace also comes with an arm support strap.

### Indications:

· Humeral shaft fractures, post-surgical fracture treatment and control of fracture site instability during the consolidation process.

■ **Colour:**  Black.

■ TP-6401 ■ TP-6402

LENGTH CM		SIZES	HUMERUS A CM
27,5	22,5	1	22,5 - 26
29,5	24,5	2	26 - 29,5
32	27	3	29,5 - 33
33	28	4	33 - 36,5
35	30	5	36,5 - 40

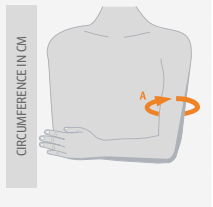



**Ref.: 94303D RIGHT** | **Ref.: 94303I LEFT**

**SHOULDER SUPPORT WITH ARM AND FOREARM STRAP**

F ... C ... S ... I ...



**Ref.: 94304D RIGHT** | **Ref.: 94304I LEFT**

**SHOULDER SUPPORT WITH FOREARM STRAP**

F ... C ... S ... I ...

**Characteristics:**

An orthosis made from breathable foam with velour exterior and inner honeycomb fabric lining, with Velcro strap and push button buckle closure systems. The support is reinforced by a 0.5 mm-thick thermoplastic core to increase its support capacity, prevent malformation and enable a personalised fit. Forearm strap with Velcro closure system and loops for the adjustment straps with inner pimpled silicone to prevent movement. Designed to facilitate free arm movement and to enable the patient to fit the support with one hand.

**Effects:**

Stabilisation of the shoulder joint.  
Shoulder subluxation and internal rotation control.  
As a method to reduce capsular ligament tension in paralysed or unstable shoulders.  
Prevention of pain and subluxation.

**Indications:**

- 94303: patients with elbow flexion contracture.
- 94304: patients with hemiparesis or hemiplegia.
- Neurological injuries to the upper limb.
- Brachial plexus injury with shoulder and arm paralysis.
- Hemiplegia caused by a stroke.
- Peripheral nerve and brain trauma injuries.
- Painful and unstable shoulder.

**Colour:** ■ Black.

SIZES	1	2	3	CIRCUMFERENCE IN CM
PERIMETER CM	22,5-28	28-34	34-40	



ANATOMIC ASPECTS

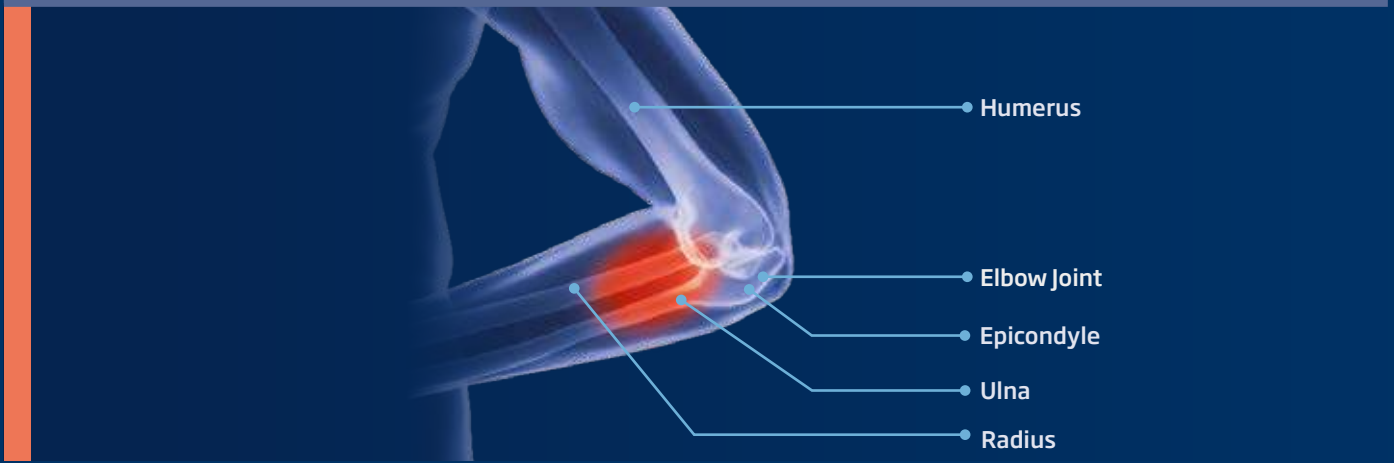

**F** Fastening    **C** Compression    **S** Stabilisation    **I** Immobilization

**Epitec® Fix** ▶ Epicondylitis Armband



Exhibitor

**Ref.: Exp-E21-Cartón**  
Units: 10  
Sizes: 50 x 20 cm



**ADJUSTABLE SILICONE**

Silicone points which stick to the skin by pressure and impede slipping of the orthosis on the forearm.



**FASTENING STRAP**

It adjusts to the forearm and wraps around itself with a plastic buckle joined to an elastic regulating band which allows individualized adaptation of pressure according to a fixed scale. The area of closure is reinforced with soft Velcro to achieve a stronger and longer-lasting adjustment.



**CUSHION**

Made of viscoelastic material with special pressure points which apply a selective pressure at the same time as an effective massage and is lined on one side with a soft hypoallergenic towel and on the other with micro-velcro which allows it to stick to the orthosis and thus avoiding slipping.



**SOUL OF THERMOPLASTIC**

Molded and shaped to fit the shape of the upper arm and serves as subject to the locking pin buckle. When performing the compression positions of the forearm muscles causing decompression and relief.



Ref.: EP-21G GREY    Ref.: EP-21V GREEN

**F** • **C** ... **S** .. **I** •

**EPITEC FIX EPICONDYLITIS ARMBAND**

SIZES	ONE SIZE	
-------	----------	--

With the EPITEC FIX straps, pressure is applied through a viscoelastic cushion with special adjustment points. Correctly positioned, these reduce the force of traction which results from the insertion of the epicondyle musculature tendon; achieving this through the orientation of the muscular fibres.

**Characteristics:**

The external side is made with highly resistant cushioned materials, internally with a moulded and shaped thermoformed plastic shell, and with silicone points that stick to the skin's pressure. Easily regulated with the closing band and the elastic band.

**Indications:**

- Prevention of sporting and work-related injuries.
- Epicondylitis (tennis elbow).
- Epitrocleitis (golfer's elbow).

**Colours:**

- EP-21G: Grey.
- EP-21V: Green.



Epitec® Fix Video



Ref.: EP-20A

F • C ••• S •• I •

**EPICONDYLITIS ARMBAND**

SIZES	ONE SIZE	
-------	----------	--

The design of the condylar pad exerts selective compression

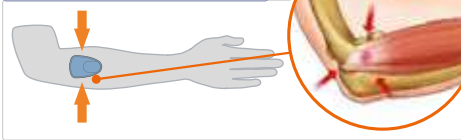

**Characteristics:**

Made of velour on both sides and reinforced with a core of polyethylene and plastazote padding. The closure strap is adjusted on the forearm and fastens back on itself, making it individually adaptable according to the pressure exerted by its elasticated cuff with hook fastener.

**Indications:**

- Sports and work injury prevention.
- Epicondylitis (tennis elbow).
- Epitrochleitis (golfer's elbow).

**Colour:** ■ Blue.

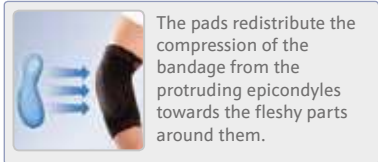

Ref.: 8301 BEIGE

Ref.: 9301 BLACK

F ••• C •••• S • I •

**ELASTIC ELBOW SUPPORT WITH VISCOLASTIC PADS**

SIZES	PERIMETER CM	LENGTH CM
1	17-19	21,5
2	19-21	22
3	21-23	22,5
4	23-25	24
5	25-27	24
6	27-29	24
7	29-31	24,5

12CM FROM THE ELBOW



**Characteristics:**

Developed in breathable elastic woven fabric using flat weaving, it incorporates two anatomically-shaped Viscolastic pads which redistribute the compression on the epicondyle and epitrochlea.

**Indications:**

- Epicondyle pathologies (e.g. tennis elbow, golf elbow), osteoarthritis and arthritis.
- States of postoperative and post-traumatic irritation, tendinopathies, epicondylitis, prevention of sports or work-related injuries.

**Colours:**

8301: ■ Beige.  
9301: ■ Black.



Ref.: IC-40

F •••• C •••• S •••• I ••••

**ELBOW IMMOBILISER WITHOUT FLEXION**

SIZES	PERIMETER CM	HEIGHT CM	
1	22-27	34	
2	27-32	35	
3	32-37	37	

**Characteristics:**

Orthosis that immobilises the elbow in extension. Made from terrycloth on the inside and honeycomb fabric and velour on the outside; featuring rigid aluminium splints on the back and sides; fastening by means of Velcro straps. It is designed with an opening in the front to enable the use of peripheral venous access devices. The material is breathable and washable for proper hygiene of the orthosis. It comes in three sizes and can be used interchangeably on the left and right arm.

**Indications:**

- Patients that require the use of a peripheral venous access device during treatment.
- The elbow immobiliser keeps the elbow joint immobilised in extension.

**Colour:** ■ Grey.

ANATOMIC ASPECTS

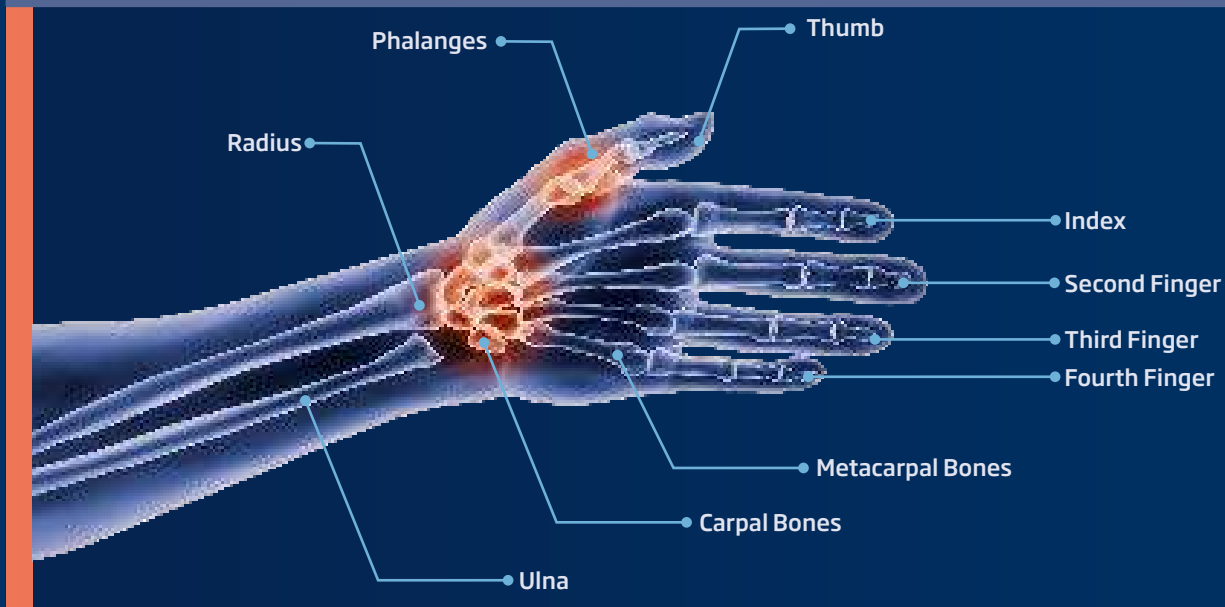

**F** Fastening    **C** Compression    **S** Stabilisation    **I** Immobilization

**Manutec®** >Wrist Supports



Ref.: MF-D50 RIGHT    Ref.: MF-I50 LEFT

**F** ... **C** .... **S** .... **I** ....

WRIST SUPPORT

SIZES	PERIMETER CM	WRIST
1	12-15	
2	15-17	
3	17-19	
4	19-21	

- Characteristics:**  
Wrist support with splint made of a soft elastic material, with adjustable Velcro fastenings. Mouldable removable plates with semi-spherical support on the palm.
- Indications:**
- Immobilisation of the wrist.
  - Painful and inflammatory episodes.
  - Instability.
  - Rehabilitation.
- Colour:** Beige.

- Antibacterial fabric
- Fabric with massage effect



Ref.: MF-D60 RIGHT    Ref.: MF-I60 LEFT

**F** ... **C** .... **S** .... **I** ....

WRIST SUPPORT

SIZES	PERIMETER CM	WRIST
1	12-15	
2	15-17	
3	17-19	
4	19-21	

- Characteristics:**  
Wrist support with splint made of a soft elastic material, with adjustable Velcro fastenings and elastic Velcro straps on the wrist. Mouldable removable plates with semi-spherical support on the palm area.
- Indications:**
- Immobilisation of the wrist.
  - Painful and inflammatory episodes.
  - Instability.
  - Rehabilitation.
- Colour:** Beige.

- Antibacterial fabric
- Fabric with massage effect

## Manutec® ▶ Wrist Supports



Antibacterial fabric



Fabric with massage effect

Ref.: MP-D70 RIGHT

Ref.: MP-I70 LEFT

F

...

C

...

S

...

I

...

### SHORT WRIST SUPPORT

SIZES	PERIMETER CM	WRIST	LENGTH
1	12-15		
2	15-17		13 cm
3	17-19		
4	19-21		

#### Characteristics:

Wrist support with extractable and mouldable thumb splint, made of a soft elastic fabric and Velcro fastener.

#### Indications:

· Immobilisation and protection of the metacarpophalangeal and carpometacarpal joints.

#### Colour:

■ Beige.



Antibacterial fabric



Fabric with massage effect

Ref.: MFP-D80  
RIGHT

Ref.: MFP-I80  
LEFT

F

...

C

...

S

...

I

...

### LONG OPEN ELASTIC WRIST SUPPORT WITH PALM & THUMB SPLINT

SIZES	PERIMETER CM	WRIST	LENGTH
1	12-15		
2	15-17		20 cm
3	17-19		
4	19-21		

#### Characteristics:

Long wrist support with thumb splint, elastic and soft material, removable and mouldable plate with semi-spherical palm support and thumb plate.

#### Indications:

· Immobilisation and protection of the metacarpophalangeal and carpometacarpal joints.

#### Colour:

■ Beige.

MAIN FEATURES

**MULTI-CELL FABRIC**  
Breathable

**COTTON**  
Better fit

**FOAM**  
Greater confort

**GREAT BREATHABLE**   **PERFECT FIT**



SHORT

Ref.: MF-D52 RIGHT

Ref.: MF-I52 LEFT



MEDIUM

Ref.: MF-D61 RIGHT

Ref.: MF-I61 LEFT



LONG

Ref.: MF-D90 RIGHT

Ref.: MF-I90 LEFT

SEMI-RIGID WRIST SUPPORT WITH PALMAR SPLINT

SIZES	PERIMETER CM	WRIST	LENGTH
1	12-16		
2	16-18		17 cm
3	18-20		

SIZES	PERIMETER CM	WRIST	LENGTH
UNI	13-23		
1	12-16		21 cm
2	16-18		
3	18-20		

SIZES	PERIMETER CM	WRIST	LENGTH
1	14-16		
2	16-18		27 cm
3	18-20		

The dorsal splints are made of aluminium for the MF-D61/ MF-I61 UNI models.

**Characteristics:**

It features a breathable, lightweight fabric base with a layer of cotton in contact with the skin providing greater comfort and enabling free movement of the fingers. The palmar splint is made from malleable aluminium and it features 2 plastic dorsal supports for effective bracing of the wrist according to the desired angle. Fitting is simple thanks to the dorsal elastic fabric and closure is fast by means of trimmable Velcro straps and anti-torsion buckles.

**Indications:**

- Carpal tunnel syndrome.
- Wrist sprains.
- Osteoarthritis.
- Tendinitis.
- Overloading of the wrist joints.
- Residual instability.
- Pre/post-surgical and post-injury treatment.

**Colour:**  Black.

F ... C ... S ... I ...



Ref.: MP-D72 RIGHT

Ref.: MP-I72 LEFT

F

C

S

I

SHORT SEMI-RIGID WRIST SUPPORT WITH THUMB SPLINT

SIZES	PERIMETER CM	WRIST	LENGTH
1	12-16		
2	16-18		14,5 cm
3	18-20		

**Characteristics:**

It features a breathable, lightweight fabric base with a layer of cotton in contact with the skin providing greater comfort and enabling free movement of the fingers. The thumb splint is made from malleable aluminium and it features 2 plastic dorsal supports for effective bracing of the thumb according to the desired angles. In addition, the radial splint features a semi-circular design for increased comfort and improved positioning of the thumb. Fitting is simple thanks to the dorsal elastic fabric and closure is fast by means of trimmable Velcro straps and anti-torsion buckles.

**Indications:**

- Rhizarthrosis.
- Ulnar collateral ligament injury of the thumb (skier's thumb).
- Tendinitis.
- De Quervain's tenosynovitis.
- Overloading of the wrist and thumb joints.
- Residual instability.
- Pre/post-surgical and post-injury treatment.

**Colour:** Black.



In addition, the radial splint features a semi-circular design.



Ref.: MFP-D81  
RIGHT

Ref.: MFP-I81  
LEFT

F

C

S

I

MEDIUM SEMI-RIGID WRIST SUPPORT WITH PALMAR/THUMB SPLINT

SIZES	PERIMETER CM	WRIST	LENGTH
1	12-16		
2	16-18		21 cm
3	18-20		

**Characteristics:**

It features a breathable, lightweight fabric base with a layer of cotton in contact with the skin providing greater comfort and enabling free movement of the fingers. The palmar and thumb splints are made from malleable aluminium and it features 2 plastic dorsal supports for effective bracing of the wrist and thumb according to the desired angles. In addition, the radial splint features a semi-circular design for increased comfort and improved positioning of the thumb. Fitting is simple thanks to the dorsal elastic fabric and closure is fast by means of trimmable Velcro straps and anti-torsion buckles.

**Indications:**

- Combined wrist + thumb injuries.
- Rhizarthrosis.
- Ulnar collateral ligament injury of the thumb (skier's thumb).
- Tendinitis.
- De Quervain's tenosynovitis.
- Overloading of the wrist and thumb joints.
- Residual instability.
- Pre/post-surgical and post-injury treatment.

**Colour:** Black.



Ref.: MFP-D91  
RIGHT

Ref.: MFP-I91  
LEFT

F

C

S

I

FAST LACING SEMI-RIGID WRIST SUPPORT WITH PALMAR/DORSAL/THUMB SPLINTS

SIZES	PERIMETER CM	WRIST	LENGTH
1	12-16		
2	16-18		16 cm
3	18-20		

**Characteristics:**

It features a breathable, lightweight fabric base with a layer of cotton in contact with the skin providing greater comfort and enabling free movement of the fingers. The palmar, dorsal and thumb splints are made from malleable aluminium for effective bracing of the wrist and thumb according to the desired angles. In addition, the radial splint features a semi-circular design for increased comfort and improved positioning of the thumb. Fitting is simple thanks to the elastic ulnar fabric and closure, by means of a fastening system with laces, is fast and provides a snug, uniform fit of the orthosis to the wrist.

**Indications:**

- Combined wrist + thumb injuries.
- Rhizarthrosis.
- Ulnar collateral ligament injury of the thumb (skier's thumb).
- Tendinitis.
- De Quervain's tenosynovitis.
- Overloading of the wrist and thumb joints.
- Residual instability.
- Pre/post-surgical and post-injury treatment.

**Colour:** Black.





Ref.: MF-D92 RIGHT      Ref.: MF-I92 LEFT

F . . . . C . . . . S . . . . I . . . .

**FAST LACING SEMI-RIGID WRIST SUPPORT WITH PALMAR/DORSAL SPLINTS**

SIZES	PERIMETER CM	WRIST	LENGTH
1	12-16		
2	16-18		
3	18-20		20,5 cm

**Characteristics:**

It features a breathable, lightweight fabric base with a layer of cotton in contact with the skin providing greater comfort and enabling free movement of the fingers. The palmar and dorsal splints are made from malleable aluminium for effective bracing of the wrist according to the desired angle. Fitting is simple thanks to the elastic radial fabric and closure, by means of a fastening system with laces, is fast and provides a snug, uniform fit of the orthosis to the wrist.

**Indications:**

- Carpal tunnel syndrome.
- Wrist sprains.
- Osteoarthritis.
- Tendinitis.
- Overloading of the wrist joints.
- Residual instability.
- Pre/post-surgical and post-injury treatment.

**Colour:** ■ Black.



Ref.: MF-D93 RIGHT      Ref.: MF-I93 LEFT

F . . . . C . . . . S . . . . I . . . .

**SEMI-RIGID WRIST SUPPORT WITH PALMAR/DORSAL SPLINTS 2ND AND 3RD METACARPALS**

SIZES	PERIMETER CM	WRIST	LENGTH
1	14-16		
2	16-18		
3	18-20		28 cm

**Characteristics:**

It features a breathable, lightweight fabric base with a layer of cotton in contact with the skin providing greater comfort and enabling free movement of the fingers. The palmar and dorsal splints are made from malleable aluminium for effective and separate bracing of the wrist and fingers according to the desired angles. Fitting is simple thanks to the radial elastic fabric and closure is fast by means of trimmable Velcro straps and anti-torsion buckles.

**Indications:**

- Fracture of the 2nd or 3rd metacarpals (boxer's fracture).
- Injuries to the wrist, hand and 2nd or 3rd fingers.
- Dislocations and sprains.
- Pre/post-surgical and post-injury treatment.

**Colour:** ■ Black.

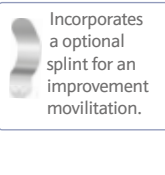
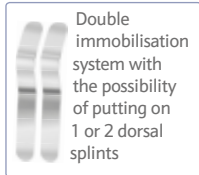

Ref.: MF-D95 RIGHT      Ref.: MF-I95 LEFT

F . . . . C . . . . S . . . . I . . . .

**SEMI-RIGID WRIST SUPPORT WITH PALMAR/DORSAL SPLINTS 4TH AND 5TH METACARPALS**

SIZES	PERIMETER CM	WRIST	LENGTH
1	14-16		
2	16-18		
3	18-20		28 cm

**Characteristics:**

It features a breathable, lightweight fabric base with a layer of cotton in contact with the skin providing greater comfort and enabling free movement of the fingers. The palmar and dorsal splints are made from malleable aluminium for effective and separate bracing of the wrist and fingers according to the desired angles. Fitting is simple thanks to the radial elastic fabric and closure is fast by means of trimmable Velcro straps and anti-torsion buckles.

**Indications:**

- Fracture of the 4th or 5th metacarpals (boxer's fracture).
- Injuries to the wrist, hand and 4th or 5th fingers.
- Dislocations and sprains.
- Pre/post-surgical and post-injury treatment.

**Colour:** ■ Black.

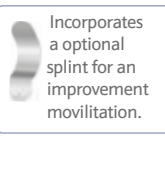
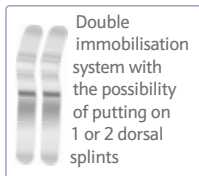



## MAIN FEATURES



### LAST GENERATION MATERIALS

Triple layer transpirable material (foam, velour, sponge).



### BILATERAL DESIGN

The design allows the brace to be used on the left and on the right.



### AREAS OF TRANSPIRATION AND VENTILATION

Aid the movement of air, dissipating the humidity.



### IMMOBILISING SYSTEM

Triple immobilising system.



**Ref.: M760**  
GREY

**Ref.: M660**  
BEIGE

**F** ... **C** ... **S** ... **I** ...

## IMMOBILISING WRIST SUPPORT WITH PALM SPLINT (AMBIDEXTROUS)

SIZES	PERIMETER CM
1	14-18
2	18-22

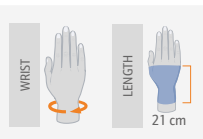

A new closure and adjustment system consisting of a forearm strap and wrist closure, whose single strap design enables wrist and hand adjustment.



In the palmar area, a double velcro strap system enables adjustment to the width of the hand's metacarpal area.

### Characteristics:

Wrist splint manufactured from breathable velour, made using last generation materials (triple layer: foam, velour, sponge), with a triple immobilisation system comprising a malleable aluminium palm splint and medial-lateral anatomically shaped strips for adaptation.

### Indications:

- Wrist immobilisation.
- Post-trauma.
- Postsurgery.
- Painful or swollen sequelae.
- Instability.
- Rehabilitation.

### Colours:

- M760: Grey.
- M660: Beige.



**Ref.: M760P** GREY

**Ref.: M660P** BEIGE

## MANUTEC FIX THUMB ATTACHMENT

SIZES	ONE SIZE
-------	----------

### Characteristics:

Thumb attachment made from velour featuring an inner malleable aluminium splint to achieve the abduction required by the patient. It can be attached to wrist support brace models M660 and M760 with Velcro to obtain a complete wrist support brace with palmar and thumb immobilisation.

### Indications:

- Tendinitis, painful and inflammatory consequences, carpometacarpal and metacarpophalangeal joint instability, sporting injuries (e.g. skier's thumb).
- Carpometacarpal and metacarpophalangeal joint irritation.
- Immobilisation of the trapeziometacarpal joint (rizarthrosis).

### Colours:

- M760P: Grey.
- M660P: Beige.



## ANATOMIC ASPECTS

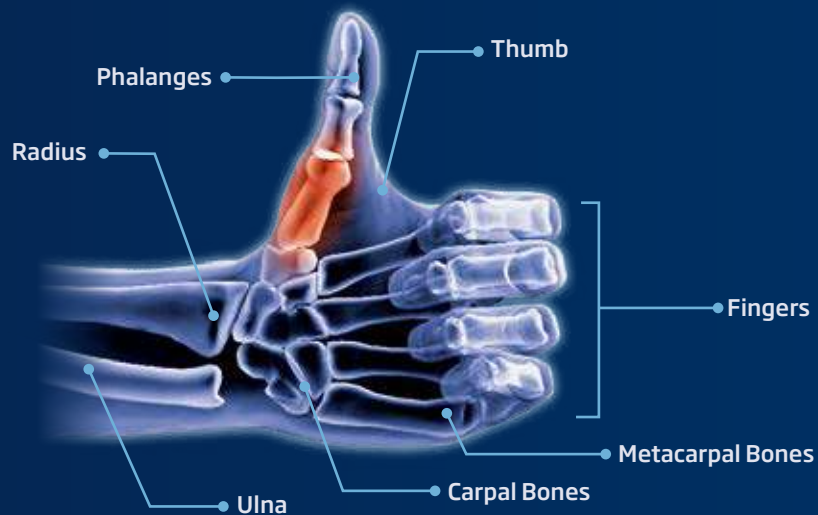

**F** Fastening   **C** Compression   **S** Stabilisation   **I** Immobilization

## Manutec® Fix Rizart ▶ Bilateral Wrist Support



▶ Manutec® Fix Video

Sin  
**LATEX**  
free

### MAIN FEATURES



**LAST GENERATION MATERIALS**  
Triple layer transpirable material (foam, velour, sponge).



**BILATERAL DESIGN**  
The design allows the brace to be used on the left and on the right.



**AREAS OF TRANSPIRATION AND VENTILATION**  
Aid the movement of air, dissipating the humidity.



**IMMOBILISER SYSTEM**  
Of the trapeziummetacarpal joint.



**Ref.: M770**  
GREY

**Ref.: M670**  
BEIGE

**F** ... **C** .. **S** ... **I** ....

### BREATHABLE THUMB IMMOBILISING SPLINT (AMBIDEXTROUS)

SIZES	PERIMETER CM	LENGTH
1	14-18	11
2	18-22	13

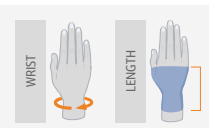

#### Characteristics:

The splint is made of breathable velour, which has orifices on the surface to facilitate the movement of air. With an immobiliser system which consists of a malleable aluminium splint which can be shaped to the morphology of the patient. Bilateral design which can be adapted for both the left and right hand. Closing system with a velour strap, and hook closure.

#### Indications:

- Tendonitis.
- Painfull or swollen sequelae.
- Instability of the trapeziummetacarpal joints.
- Sports injuries (eg.: skier's thumb).
- Irritations of the trapeziummetacarpal joints.
- Immobilization of the trapeziummetacarpal joint (Thumb rhizarthrosis).

#### Colours:

M770: Grey.  
M670: Beige.

## MAIN FEATURES



Metal core



Easy closing System with only one hand



Ref.: M780D RIGHT

Ref.: M780I LEFT

F ... C .. S ... I ....

### THUMB BRACE CMC

SIZES	PERIMETER CM
1	16-19
2	19-23
3	23-26

AT THE HEIGHT OF THE METACARPOPHALANGEAL JOINT

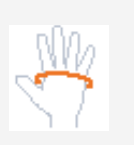

#### Characteristics:

It stabilises the base joint of the thumb and places the first metacarpal in its functional position. It places the thumb in an anatomically correct position and enables the other fingers to move properly, ensuring the functionality of the hand.

The design with double injection of materials and the rounded edges guarantee maximum comfort of use. It has a fastening system, secured by a metal core, that enables the degree of stability of the trapeziometacarpal joint to be adjusted as required.

#### Effects:

- Support and comfort for the first CMC joint.
- Keeps the thumb in the functional position.
- Relieves pain and reduces the symptoms of loss of strength.

#### Indications:

- Osteoarthritis of the first CMC joint.
- Post-surgical treatment of the first CMC joint.
- Arthroplasty of the first CMC joint.
- Instability of the first CMC joint.
- Rhizarthrosis.

#### Colour:

- Grey.

## Wrist support braces



Ref.: MN3050

F . C .. S .. I ..

### WRIST SUPPORT BRACE WITH THUMB ABDUCTION

SIZES	ONE SIZE
-------	----------

#### Characteristics:

A wrist support brace made from breathable material which enables compression and traction of the thumb to be adjusted according to the needs of the patient. It features an elastic strap for stabilisation and abduction of the metacarpophalangeal joint of the thumb. Available as an accessory is a silicone pad designed to increase and maintain the abduction of the metacarpophalangeal joint, thereby preventing thumb opposition.

#### Indications:

- Positioning of the thumb.
- Mild instability.
- Stabilisation and abduction of the metacarpophalangeal joint.

#### Colour:

- Grey.



Ref.: FP-D71 RIGHT | Ref.: FP-I71 LEFT

F ... C .. S ... I .....

THUMB SPLINT IN THERMOPLASTIC

SIZES	PERIMETER CM	LENGTH CM	WRIST	LENGTH
1	<17	11		
2	17-19	12		
3	>19	13		

Characteristics:

Posture thumb splint in thermoplastic, lined with plastazote and fastening with Velcro strap at wrist level.

Indications:

- Prevents deviations in rheumatic deformities.
- In postoperative care. In rhizarthrosis of the thumb (by immobilisation of the trapeziummetacarpal joint).
- Possibility of molding with hot air pistol.

Colour: Beige.



Ref.: FP-D74 RIGHT | Ref.: FP-I74 LEFT

F .. C .. S ... I .....

BREATHABLE THUMB IMMOBILISING SPLINT

SIZES	PERIMETER CM	LENGTH CM	WRIST	LENGTH
1	<17	11		
2	17-19	12		
3	>19	13		

The breathable lining can be ordered separately.  
Ref: Forro-FP74

Characteristics:

Immobilising splint in thermoplastic which includes a very comfortable breathable interface. The splint has a small micro-velcro fastener which can be adjusted to fit to the required length.

Indications:

- Tendonitis.
- Painful and inflammatory sequelae.
- Instabilities of metacarpophalangeal joints.
- Sports injuries (eg, skier's thumb).
- Irritations of the metacarpophalangeal joints.
- Immobilisation of the trapezo-metacarpal joint. (Rhizarthrosis of the thumb).
- Immobilisation of the metacarpophalangeal joints in the thumb (after injury or surgery)

Colour: Beige.



Ref.: FP-D75 RIGHT | Ref.: FP-I75 LEFT

F .. C .. S ... I .....

QUERVAIN SPLINT

SIZES	PERIMETER CM	LENGTH CM	WRIST	LENGTH
1	<17	18		
2	17-19	20		
3	>19	22		

Characteristics:

Thermoplastic immobiliser splint lined in plastazote, with two rigid Velcro fasteners at wrist and forearm level and an elastic strap at palm level.

Indications:

- Tendonitis.
- Painful and inflammatory episodes.
- Instabilities of the carpometacarpal and metacarpophalangeal joints.
- Injuries of the lateral ligaments of the primary metacarpal (sports and posttraumatic injuries).
- Irritations of the carpometacarpal and metacarpophalangeal joints.
- Immobilisation of the trapezium-metacarpal joint (Rhizarthrosis of the thumb).
- Immobilisation of the carpometacarpal and metacarpophalangeal joints of the thumb (post-traumatic and post-surgical).

Colour: Beige.



# Finger immobilising glove splint



Ref.: M710D RIGHT  
Ref.: M710I LEFT

F ... C ... S ... I ...

**GLOVE SPLINT FOR THE IMMOBILISATION OF THE METACARPOPHALANGEAL AND INTERPHALANGEAL JOINTS OF THE HAND AND FINGERS IN EXTENSION OR FLEXION**

SIZES	PERIMETER CM	FINGER LENGTH CM
1	15-17	7,5-8,5
2	17-19	8,5-9,5
3	19-22	9,5-11
4	22-25	11-12,5

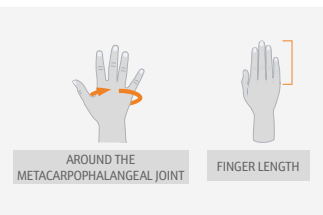

**Characteristics:**

A glove made from velour and honeycomb fabric in the interior, hook closure with safety strap. Independent finger splints with metal strip and closure system with velour and hook fastening. The finger splints are made from malleable aluminium, enabling adjustment of the extension or flexion of the metacarpophalangeal (MCP) and interphalangeal (IP) joints.

**Indications:**

- As a method for immobilising the metacarpophalangeal and interphalangeal joints.
- Finger fractures, dislocations, trauma injuries, capsular ligamentous injuries, metacarpal fractures, retractile scars in burns cases, bursitis.
- As a method of postoperative immobilisation.
- Dupuytren disease.

**Colour:**  Black.

## ACCESSORIES



Ref.: FRD10

**CLOSED-FINGER SPLINTS**

SIZES	FINGER LENGTH
1	7,5-8,5
2	8,5-9,5
3	9,5-11
4	11-12,5

FINGER LENGTH



Ref.: FRD20

**OPEN-FINGER SPLINTS**

SIZES	FINGER LENGTH
2	8,5-9,5
4	11-12,5

FINGER LENGTH



Ref.: PM10

**SPLINT TO EXTEND IMMOBILISATION TO THE WRIST JOINT**

SIZES ONE SIZE

# Stack Splints



Ref.: TP-6200

F ... C ... S ... I ...

**STACK SPLINTS**

SIZES	PERIMETER CM
1	5
2	5,5
3	5,8
4	6,1
5	6,3
5,5	6,8
6	7,3
7	7,8



**Characteristics:**

The splint is manufactured from polypropylene (flesh colour). The lower part goes from the distal zone of the finger until it exceeds the distal interphalangeus articulation, and has a thimble shape to house the tip of the finger. The upper section is joined to the lower section to leave the nail zone free, and stretches to the distal interphalangeus articulation.

**Indications:**

- Extractions of the extensor for its insertion in the dorsal face of the distal phalange.

**Packaging:** Bag with 1 unit.

**Colour:**  Beige.

# Immobilising Frog Finger Splint In Malleable Aluminium



Ref.: OM6201

F . . . . C . . . S . . . . I . . . .

## IMMOBILISING FROG FINGER SPLINT IN MALLEABLE ALUMINIUM

SIZES	PERIMETER CM
1	5,7
2	7
3	7,6

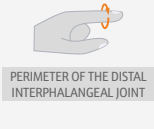

### Characteristics:

Its manufacture in malleable aluminium and its interior lining enable it to be adapted to any finger without the need for a closure system. It can be used on either hand. Foam avoids sweating in the area.

### Indications:

- It is indicated for cases where it is necessary to immobilise the distal interphalangeal joint and can be adjusted to the desired position of the finger.

**Colour:**  Blue.

## Thermoplastic Splints

Ref.: TP-6100D  
RIGHTRef.: TP-6100I  
LEFTRef.: TP-6105D  
RIGHTRef.: TP-6105I  
LEFT

### WRIST IMMOBILIZATION SPLINT (IN DORSIFLEXION 35°-40°)

### WRIST IMMOBILIZATION SPLINT (IN DORSIFLEXION 20°)

Ref: TP-6100

Ref: TP-6105

SIZES	PERIMETER CM	LENGTH CM	SIZES	PERIMETER CM	LENGTH CM
1	14-16	22	1	<15	21
2	16-18	24	2	15-17	22
3	18-20	26	3	17-19	23
			4	>19	24



### Characteristics:

Made from thermoplastic and lined with Plastazote, it has 3 velour straps with safety inserts in the wrist and forearm and a hook closure system. The plastic can be moulded under a current of hot air.

### Indications:

- As a general treatment for pain or post-traumatic pain, helps to stabilise the wrist after arthrodesis.
- As treatment post-operatively, for carpal tunnel syndrome, tenosynovitis or inflammation in the carpal region.
- Its features allow for small adjustments or adaptations.

**Colour:**  White.

Ref.: TP-6101DA  
RIGHTRef.: TP-6101IA  
LEFT

F . . . C . . . S . . . I . . .

## ARTICULATED WRIST ORTHOSIS

SIZES	WIDTH CM	LENGTH CM
1	6-7	34
2	7-8	36
3	8-9	38
4	9-10	40

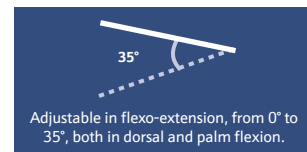

### Characteristics:

Made of two pieces of thermoplastic (palm and forearm), connected by a wrist joint that allows you to adjust the palm and dorsal flexion of the orthosis, limiting the range of movements of the wrist joint or immobilizing it in a set position. The lateral splints contain slots that allow you to move the thermoplastic pieces closer to or further from each other, which allows us to adjust the orthosis to each patient's measurements. They feature an interior terrycloth lining to avoid sweating. It includes 3 velour straps with a security pin on the wrist and forearm, and a Velcro fastening system. The orthosis can be molded using a hot-air gun.

### Indications:

- All pre and post-op conservative treatments that require functional support or immobilization of the wrist, such as carpal tunnel syndrome, chronic polyarthritis, and rheumatoid arthritis.
- It is also indicated for central or peripheral neurological damage (spastic and flaccid paralysis), treatment for the prevention of rheumatoid deformities, as well as pain relief and anti-inflammatory treatment.

**Colour:**  Beige.

# Thermoplastic Splints



Ref.: TP-6101D      Ref.: TP-6101I  
RIGHT                      LEFT

F ... C .. S ... I ...

## FUNCTIONAL POSITION HAND IMMOBILISATION SPLINT WITH THUMB IN OPPOSITION

SIZES	WIDTH CM	LENGTH CM	HAND WIDTH	LENGTH
1	6-7	34		
2	7-8	36		
3	8-9	38		
4	9-10	40		

### Characteristics:

Made from thermoplastic and lined with absorbent terry cloth to absorb moisture, it has 3 velour straps with safety inserts in the wrist and forearm and a hook closure system. The plastic can be moulded under a current of hot air.

### Indications:

- Neurological damage of central or peripheral origin (spastic and flaccid paralysis), as treatment for the prevention of rheumatic deformities as well as for pain relief and to reduce inflammation.
- Carpal tunnel syndrome.

Colour:  White.



Ref.: TP-6102D      Ref.: TP-6102I  
RIGHT                      LEFT

F ... C .. S ... I ...

## ANTI-SPASTICITY HAND IMMOBILISATION SPLINT

SIZES	WIDTH CM	LENGTH CM	HAND WIDTH	LENGTH
0	5-6	30		
1	6-7	34		
2	7-8	36		
3	8-9	38		
4	9-10	40		

### Characteristics:

Made from thermoplastic and lined with absorbent terry cloth to absorb moisture and increase comfort. The plastic can be moulded under a current of hot air. It has wrist and forearm straps with safety inserts and the thumb in velour. Restraint and control straps for MCP and IP flexion in velour, and lined with silicone.

### Indications:

- Resting splint for the treatment of pain, neurological disorders, hemiplegia.
- Especially indicated for spastic paralysis, for protecting the palm, the hand and wrist from inhibitory reflexes, preventing deformities caused by spasms and contractions and preventing claw hand.

Colour:  White.



Ref.: TP-6103D      Ref.: TP-6103I  
RIGHT                      LEFT

F ... C .. S ... I ...

## WRIST IMMOBILISATION SPLINT (IN DORSIFLEXION) WITH THUMB

SIZES	WIDTH CM	LENGTH CM	HAND WIDTH	LENGTH
1	6-7	22		
2	7-8	24		
3	8-9	26		
4	9-10	28		

### Characteristics:

Made from thermoplastic and lined with Plastazote, it has 3 velour straps with safety inserts in the wrist and forearm and a hook closure system. The plastic can be moulded under a current of hot air.

### Indications:

- As a general treatment for pain or post-traumatic pain, and helps to stabilise the wrist after arthrodesis.
- Also recommended for thumb rhizarthrosis, injuries that require metacarpophalangeal immobilisation of the thumb and Bennett's fracture dislocation.

Colour:  White.



Ref.: TP-6104D      Ref.: TP-6104I  
RIGHT                      LEFT

F ... C .. S ... I ...

## IMMOBILISATION SPLINT FOR HAND IN FLAT FUNCTIONAL POSITION

SIZES	WIDTH CM	LENGTH CM	HAND WIDTH	LENGTH
1	6-7	34		
2	7-8	36		
3	8-9	38		
4	9-10	40		

### Characteristics:

Made from thermoplastic and lined with absorbent terry cloth to absorb moisture and increase comfort. The plastic can be moulded under a current of hot air. It has wrist and forearm straps with safety inserts and the thumb in velour. Restraint and control straps for MCP flexion in velour.

### Indications:

- Neurological damage of central or peripheral origin (spastic and flaccid paralysis), as treatment for the prevention of rheumatic deformities as well as for pain relief and to reduce inflammation.
- Carpal tunnel syndrome.

Colour:  White.

ANATOMIC ASPECTS

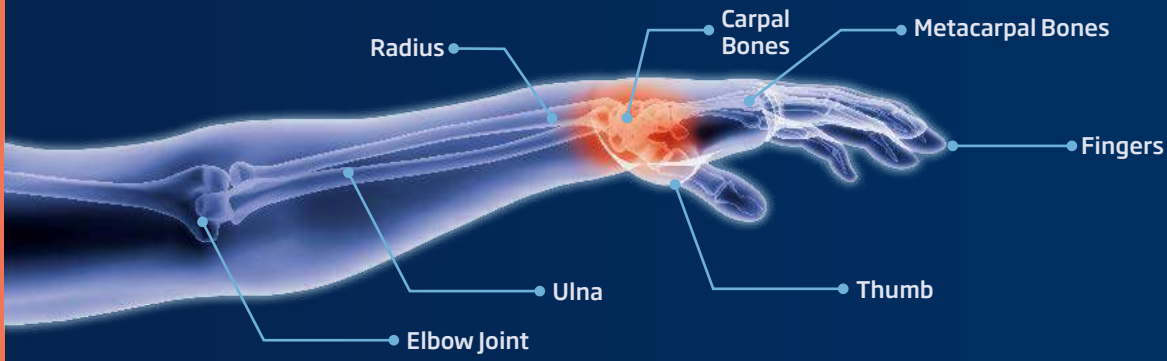

**F** Fastening    **C** Compression    **S** Stabilisation    **I** Immobilization

Malleable aluminium hand brace



SPLINT POSITIONS

Various intermediate positions between the above two extreme positions are possible, including the functional position by manually manipulating the malleable aluminium for different angles and postures.



OM6101 Video



Ref.: OM6101D RIGHT    Ref.: OM6101I LEFT

**F** .. **C** . **S** ... **I** ...

MALLEABLE ALUMINIUM THUMB AND HAND IMMOBILISING SPLINT

SIZES	WIDTH CM	LENGTH CM	HAND WIDTH	LENGTH
1	5-7	31'5		
2	7-9	34		
3	9-11	36'5		

Characteristics:

Made from a malleable aluminium core for appropriate adjustment and positioning, according to medical requirements, of the wrist, hand, fingers and thumb. Foam padding inside for greater comfort. Absorbent terrycloth lining to absorb perspiration. Velour lining exterior. The splint has various fitting options, with intermediate positions possible by manually manipulating the malleable aluminium for different postures and angles.

Suitable for:

- Central or peripheral origin neurological damage (flaccid paralysis).
- As a treatment for the prevention of rheumatic deformities.
- Pain relief and inflammation reduction.
- Carpal tunnel syndrome, due to the various postural options.

Colour: Black.

Components:  
Splint + Interdigital separator.

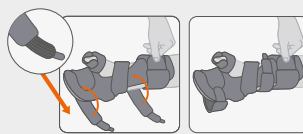

SECURING STRAPS

Securing straps great cushioning and support in micro-velcro, with easy-open tab and close. Allows you to modify the position of wrist, hand and fingers to test doctor.



ACCESSORIES



Ref.: OM001

INTERDIGITAL SEPARATOR

This accessory is to separate and align the fingers.

SIZES	ONE SIZE	1 UNIT
-------	----------	--------



Ref.: OM002I LEFT

KIT FOR SPLINT STRAPS OM6101I

You can request a kit of 3 fastening straps. Including: One for the thumb strap, a strap for fingers, wrist and forearm girth.

SIZES	ONE SIZE
-------	----------

Ref.: OM002D RIGHT

KIT FOR SPLINT STRAPS OM6101D



Ref.: OM6101IF LEFT

COVER FOR MALLEABLE HAND IMMOBILIZER SPLINT

SIZES	1	2	3
-------	---	---	---

Ref.: OM6101DF RIGHT

# Dynamic upper limb orthoses



## DYNAMIC UPPER LIMB SPLINT

### Characteristics:

The modules that make up the Orliman dynamic splint are:

- A. Palmar base.
- B. Forearm base.
- C. Fixed wrist bar.
- D. Monocentric wrist joint.
- E. Thumb tensor support.
- F. Metacarpophalangeal flexor-extensor.
- G. Interphalangeal tensor support.

### Indications:

- Injuries to the central nervous system (cerebral palsy, trauma, etc.).
- Spinal cord injuries affecting the upper limbs (poliomyelitis, amyotrophic lateral sclerosis, etc.).
- Injuries to the brachial plexus.
- Traumatic injuries affecting the upper limbs.

### Colour: ● Black.



### Ref.: KITDS/UNI

### Box kit Dynamic splint:

Ref.	Size	Description	Units
DS01	1	PALMAR BASE KIT	1
DS01	2	PALMAR BASE KIT	1
DS01	3	PALMAR BASE KIT	1
DS02	1	FOREARM BASE KIT	1
DS02	2	FOREARM BASE KIT	1
DS02	3	FOREARM BASE KIT	1
DS03	UNI	FIXED WRIST BAR KIT	1
DS04	UNI	MONOCENTRIC WRIST JOINT KIT	1
DS05	UNI	THUMB TENSOR SUPPORT KIT	1
DS06	1	METACARPOPHALANGEAL FLEXOR-EXTENSOR KIT	1
DS06	2	METACARPOPHALANGEAL FLEXOR-EXTENSOR KIT	1
DS06	3	METACARPOPHALANGEAL FLEXOR-EXTENSOR KIT	1
DS07	UNI	METACARPOPHALANGEAL FLEXOR-EXTENSOR KIT	1

## ACCESSORIES



### Ref.: DS01

#### PALMAR BASE KIT (A)

SIZES	PERIMETER CM	HAND WIDTH
1	6-7,5	
2	7,5-9	
3	9-10,5	



### Ref.: DS02

#### FOREARM BASE KIT (B)

SIZES	PERIMETER CM	CIRCUMFERENCE IN CM
1	20-25	
2	25-30	
3	30-35	



### Ref.: DS03

#### FIXED WRIST BAR KIT (C)

SIZES	ONE SIZE

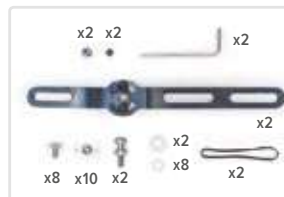

### Ref.: DS04

#### MONOCENTRIC WRIST JOINT KIT (D)

SIZES	ONE SIZE



### Ref.: DS05

#### THUMB TENSOR SUPPORT KIT (E)

SIZES	ONE SIZE



### Ref.: DS06

#### METACARPOPHALANGEAL FLEXOR-EXTENSOR KIT (F)

SIZES	PERIMETER CM
1	6-7,5
2	7,5-9
3	9-10,5

















































### Ref.: DS07

#### METACARPOPHALANGEAL FLEXOR-EXTENSOR KIT (G)

SIZES	ONE SIZE



# Dynamic upper limb orthoses

Ref.: DS01 - PALMAR BASE (A)	×	×	×	Ref.: DS07 - INTERPHALANGEAL TENSOR SUPPORT (G)	Ref.: DS06 - METACARPOPHALANGEAL FLEXOR-EXTENSOR (F)	Ref.: DS05 - THUMB TENSOR SUPPORT (E)
Ref.: DS02 - FOREARM BASE (B)		×	×			
Ref.: DS03 - FIXED WRIST BAR (C)		×				
Ref.: DS04 - MONOCENTRIC WRIST JOINT (D)			×			
						
						×
					×	
					×	
					×	×
						×
					×	×
					×	×
					×	×
						



ANATOMIC ASPECTS

TRUNK | HARNESSSES

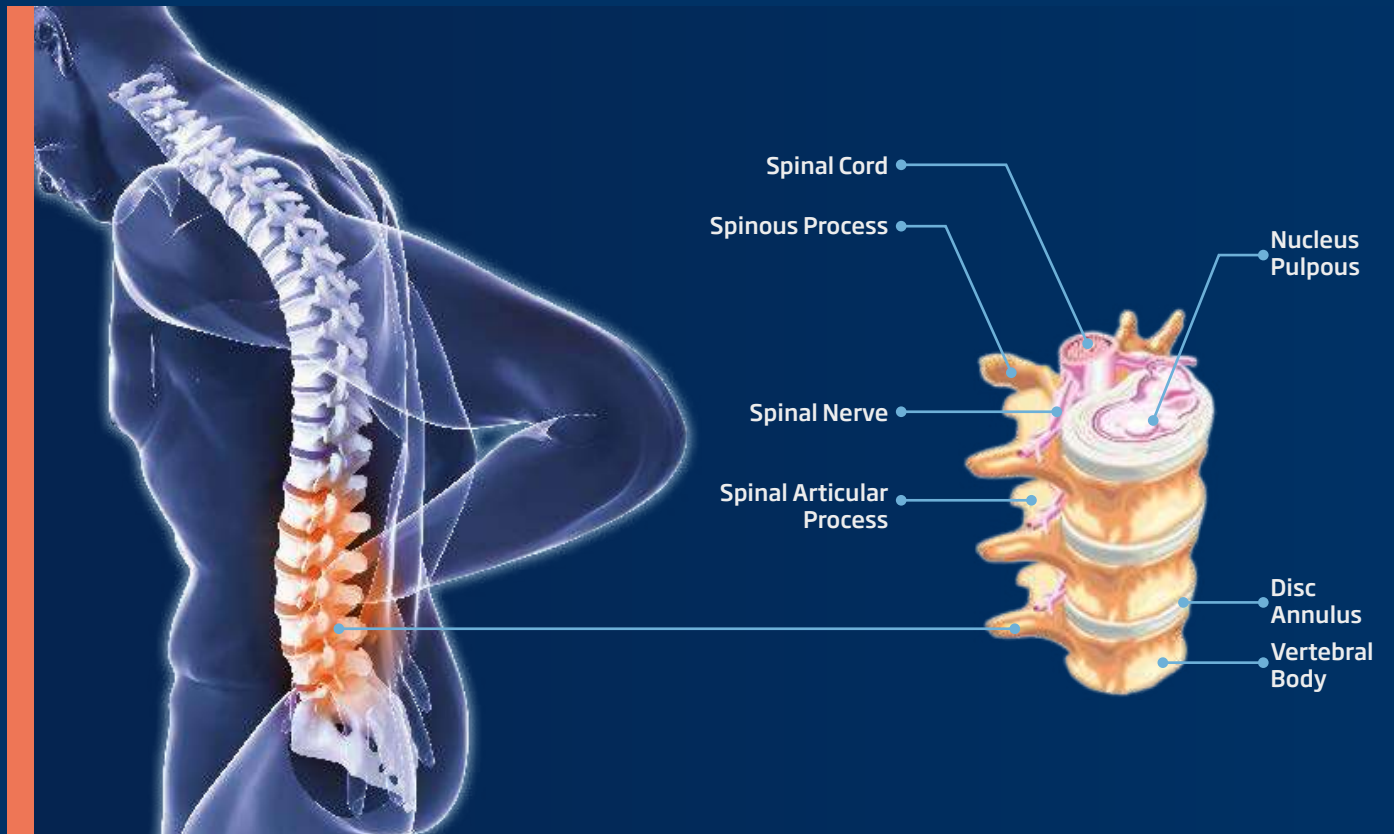
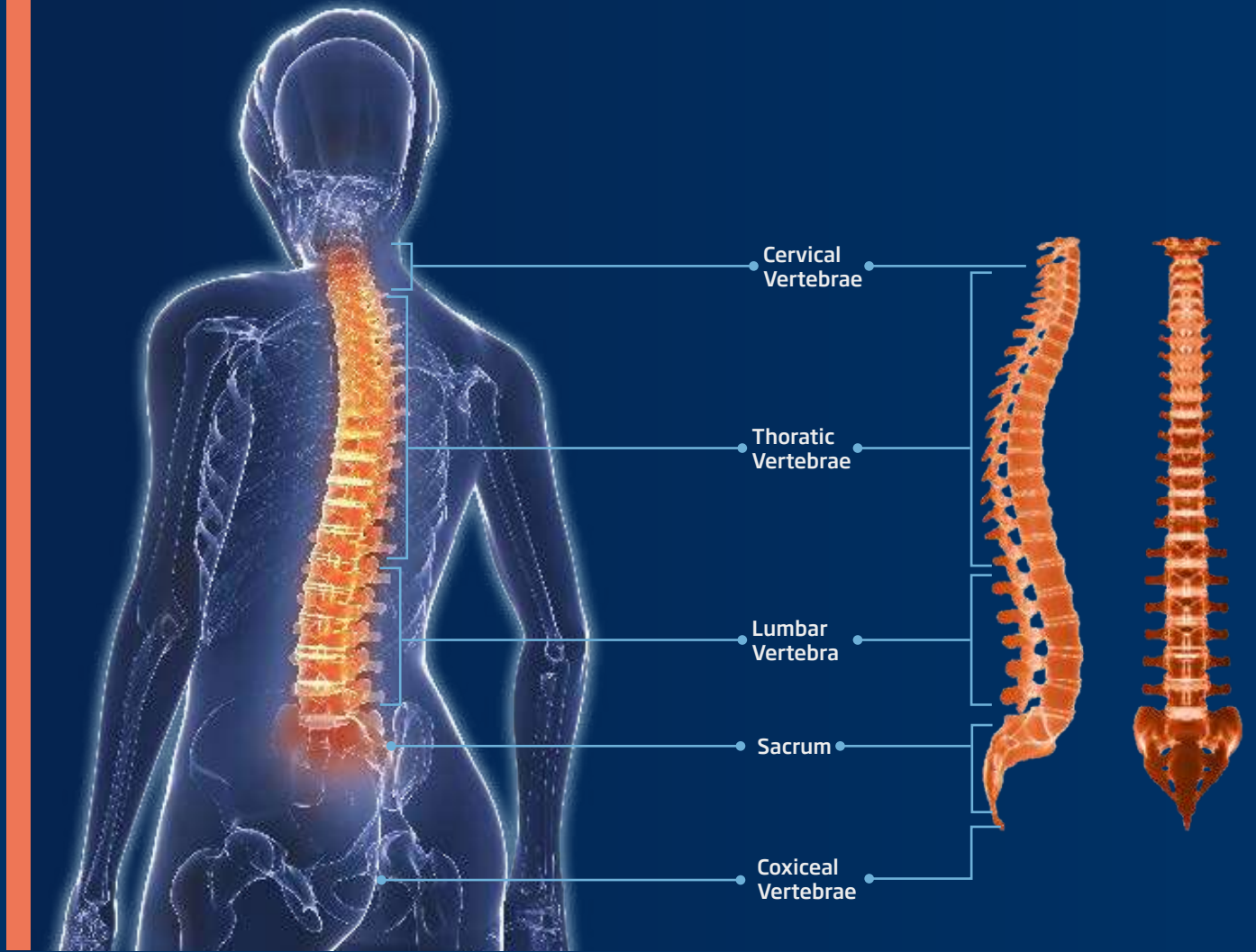

# Back Support Belts



Ref.: L-250

F ... C ... S ... I ..

## "CLASSIC" ELASTIC LUMBAR BACK SUPPORT

SIZES	PERIMETER CM	TROCHANTER	FRONT HEIGHT	BACK HEIGHT
1	75-83			
2	83-91		15 cm	
3	91-99			25 cm
4	99-107			
5	107-115			
6	115-125			
7	123-131			

### Characteristics:

Back support made with highly resistant and hardwearing fabric. Rear crossed bands and flexible strips. Front Velcro fastening.

### Indications:

- Lumbar symptoms.
- Lumbago. Lumbosciatica.
- Weak and atonic muscles.
- Degenerative processes.
- Prophylaxis of the lumbar region.
- Containment.
- Support and specific adjustment to the anatomy.

Colour:  Beige.



Ref.: A-131

F ... C ... S .. I .

## PREGNANCY BACK SUPPORT

SIZES	PERIMETER CM	ABDOMEN	FRONT HEIGHT	BACK HEIGHT
1	80-105			
2	106-122		14 cm	
3	123-140			24 cm

### Characteristics:

Short sacrolumbar back brace manufactured in multiband, transpirable, elastic material, incorporating flexible rear stays. Elastic lateral bands for the regulation of the compression with micro-velcro fastening on velour material and finger hooks for easier fitting.

### Indications:

- To relieve lumbago during pregnancy.
- Mechanical effect: the regulation of the compression contributes to the control of the hyperlordosis normally found in pregnant women during the last months of pregnancy.

Colour:  White.



Ref.: A-132

F ... C ... S .. I .

## EVENTRATION BACK SUPPORT

SIZES	PERIMETER CM	TROCHANTER	FRONT HEIGHT	BACK HEIGHT
1	70-90			
2	90-110		25 cm	
3	110-130			25 cm

### Characteristics:

Lumbosacral belt for eventrations, manufactured in multiband material, with posterior stays and velcro fastening.

### Indications:

- The eventration belt provides a general compression in the abdominal zone, due to its selective compression belt which helps to avoid the appearance of abdominal eventrations, or gives support to an existing eventration.

Colour:  White.



Ref.: CEN-410

F ... C ... S ... I ..

## LUMBAR BACK SUPPORT

SIZES	PERIMETER CM	TROCHANTER	FRONT HEIGHT	BACK HEIGHT
1	75-95			
2	95-115		16 cm	
3	115-135			26 cm

### Characteristics:

Lumbosacral support belt with a strong combination of elastic and cotton fabric, four semi-rigid steel rear stays and front Velcro fastening.

### Indications:

- Lumbalgia.
- Lumbosciatica.
- Work or sport-related overexertion.
- Strong support, containment and adjustment.
- Can be worn over clothing.

Colour:  Black.

# Back Support Belts



Ref.: T-420

F ... C ... S ... I ...

## WORK PROTECTION BACK SUPPORT

SIZES	PERIMETER CM
1	73-85
2	85-97
3	97-110
4	110-125



### Characteristics:

Elastic back support made of breathable lycra with four rear stays, interior silicone points inside to prevent slipping, adjustable tension elastic bands, double fastening system and interchangeable adjustable straps.

### Indications:

- Lumbar symptoms.
- Work-related prophylaxis.
- Prevention of back injuries.

**Colour:** ■ Black.



Ref.: T-421

F ... C ... S ... I ...

## HIGH-CONTAINMENT LUMBAR BELT

SIZES	PERIMETER CM
1	75-95
2	95-115
3	115-135



### Characteristics:

A belt made from an elastic fabric featuring 4 pre-formed, adjustable steel stays and front stays to provide greater stability and abdominal support. Adjustable elastic tension straps, double closure system. Front closure with Velcro. Pre-prepared for the fitting of optional shoulder straps.

### Indications:

- Lumbar symptoms.
- Intermittent overloading of the lumbar area.
- Repetitive movements.
- Straining.

**Colour:** ■ Black.

## ACCESSORIES



Ref.: TT420 /UNI

## ADJUSTABLE AND INTERCHANGEABLE SHOULDER STRAPS



### Characteristics:

Shoulder straps for the T-420 containment lumbar belt and the T-421 high-containment lumbar belt.

**Colour:** ■ Black.

SIZES ONE SIZE



# Back Support Belts



Ref.: BE-160 (MEN)      Ref.: BE-170 (WOMEN)

F .. C .. S .. I ..

## RIB BANDS

SIZES	PERIMETER CM	BELOW CHEST	FRONT HEIGHT	BACK HEIGHT
1	75-83			
2	83-91		16 cm	
3	91-99			16 cm
4	99-107			
5	107-115			
6	115-125			

**Characteristics:**  
Breathable multi-band elastic band with velcro fastening. (Low-cut in BE-170 model to free breasts).

**Indications:**

- Rib syndromes.
- Thoracic post-surgery.
- Containment and support.
- Very comfortable and easy to use.

**Colour:** Beige.



Ref.: BE-165 (MEN)      Ref.: BE-175 (WOMEN)

F ... C ... S .. I ..

## RIB BANDS

SIZES BE-165	PERIMETER CM	BELOW CHEST	FRONT HEIGHT	BACK HEIGHT
1	70-90			
2	90-110		16 cm	
3	110-130			16 cm
SIZES BE-175	PERIMETER CM			
ONE SIZE	65-110			

**Characteristics:**  
One-piece elastic band with Velcro fastening.

**Indications:**

- Rib syndromes.
- Thoracic post-surgery.
- Containment and support.
- Very comfortable and easy to use.

**Colour:** Beige.

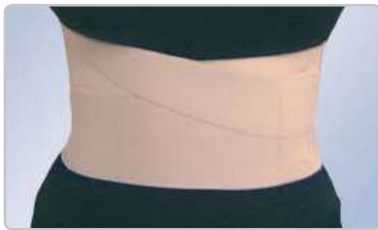

Ref.: BE-245

F ... C ... S .. I ..

## THREE BAND SUPPORT

SIZES	PERIMETER CM	ABDOMEN	FRONT HEIGHT	BACK HEIGHT
1	70-90			
2	90-110		24 cm	
3	110-130			24 cm

**Characteristics:**  
One-piece elastic band with Velcro fastening.

**Indications:**

- Lumbar containment of small and medium eventrations.
- Post-surgical and post-natal containment support.
- Containment and support.
- Very comfortable and easy to use.

**Colour:** Beige.



Ref.: BE-305

F ... C ... S .. I ..

## FOUR BAND SUPPORT

SIZES	PERIMETER CM	ABDOMEN	FRONT HEIGHT	BACK HEIGHT
1	70-90			
2	90-110		32 cm	
3	110-130			32 cm

**Characteristics:**  
One-piece elastic band with Velcro fastening.

**Indications:**

- Containment of small and medium eventrations.
- Post-surgical and post-natal containment support.
- Lumbar containment and support.
- Comfortable and easy to use.

**Colour:** Beige.



# Back Support Belts



Ref.: BEB-240



Ref.: BE-240 / BE-300

Ref.: BEB-240

Ref.: BE-240  
Ref.: BE-300

F .. C .. S . I .

## ELASTIC ABDOMINAL BAND

SIZES	PERIMETER CM	ABDOMEN	FRONT HEIGHT	BACK HEIGHT
1	75-83		24 cm (BE-240) 30 cm (BE-300)	24 cm (BE-240) 30 cm (BE-300)
2	83-91			
3	91-99			
4	99-107			
5	107-115			
6	115-125			

### Characteristics:

Band made with breathable multi-band elastic fabric. Cushioned abdominal area.

### Indications:

- Containment of small and medium eventrations.
- Post-surgical and post-natal containment band.
- Lumbar containment and support.
- Easy to use and comfortable.

### Colour:

BEB-240:  White.  
BE-240 / BE-300:  Beige.



Ref.: BE-240 A

F .. C .. S . I .

## ELASTIC ABDOMINAL PENDULUM BAND

SIZES	PERIMETER CM	ABDOMEN	FRONT HEIGHT	BACK HEIGHT
3	91-99		24 cm	24 cm
4	99-107			
5	107-115			
6	115-125			
7	125-135			
8	135-146			

### Characteristics:

Band made with breathable multi-band elastic fabric. Cushioned abdominal area.

### Indications:

- Containment of small and medium eventrations.
- Post-surgical and post-natal containment band.
- Lumbar containment and support.
- Easy to use and comfortable.

### Colour:

Beige.



Ref.: BE-280

F ... C ... S ... I ...

## ELASTIC ABDOMINAL BAND

SIZES	PERIMETER CM	ABDOMEN	FRONT HEIGHT
1	70-90		28 cm
2	90-110		
3	110-130		

### Characteristics:

A one-piece abdominal band manufactured in a cotton stretch fabric, providing comfortable contact with the patient's skin. Its design and elasticity enables optimum adaptation to the waist or pelvis. Its fastening system, featuring a large Velcro area, enables it to be fitted and attached to the entire abdominal wall.

### Indications:

- Lumbar containment of small and medium eventrations.
- Post-surgical and post-natal containment support.

### Colour:

Beige.





Ref.: COL-245/COL-247/COL-249 (24 cm)

Ref.: COL-165/COL-167/COL-169 (16 cm)

F ... C ... S . I .

## ABDOMINAL SUPPORT FOR OSTOMY PATIENTS WITH ORIFICE

SIZES	PERIMETER CM
1	75-85
2	85-95
3	95-105
4	105-120

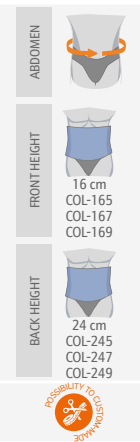

REFERENCE	HEIGHT CM	Ø STOMA MM
COL-245	24	50
COL-247	24	75
COL-249	24	90
COL-165	16	50
COL-167	16	75
COL-169	16	90

Opening located 4 cm from lower edge.

### Components:

Includes a band to cover bag.  
A reinforcement plate. Ref.: PT-054.

### Characteristics:

Abdominal support made with elastic fabric joined to a rigid and non-malleable piece for greater containment of the stoma region. It has 8 flexible stays that avoid the felt from ruching up.

### Indications:

- Post-operative care in colostomies and ileostomies.
- Abdominal containment, mainly in the area of the stoma.

Colour: ■ Beige.



Ref.: PT-054

## REINFORCEMENT PLATE (ACCESSORY)

SIZES	00 sin agujero	05	07	09
		5,2 cm	7,5 cm	9 cm



Ref.: COL-240 (24 cm)

Ref.: COL-160 (16 cm)

F ... C ... S . I .

## ABDOMINAL SUPPORT FOR OSTOMY PATIENTS WITHOUT ORIFICE

SIZES	PERIMETER CM
1	75-85
2	85-95
3	95-105
4	105-120



REFERENCE	HEIGHT CM
COL-240	24
COL-160	16

### Characteristics:

Abdominal support made with multi-band elastic fabric joined to a rigid and non-malleable piece for greater containment of the stoma region. It has 8 flexible stays that avoid the felt from ruching up.

### Indications:

- Post-operative care in colostomies and ileostomies.
- Abdominal containment, mainly in the area of the stoma.

Colour: ■ Beige.

### Components:

- A band to cover bag.
- Reinforcement plate.
- Edging and measurement tables (50-75-90 mm).



# Dorsal Supports



Ref.: E-240

F .. C . S .. I ..

## STRONG SHOULDER SUPPORT

SIZES	PERIMETER CM
1	75-85
2	80-92
3	85-97
4	92-104
5	98-110
6	104-120

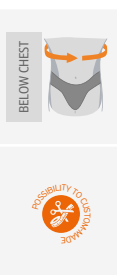

### Characteristics:

Includes two cotton elastic fabric, ring bands, independent for each shoulders. The ends of the bands exert gradual traction, achieving repulsion of the shoulders and correcting poor kyphotic posture.

### Indications:

- Dorsalgia.
- As corrector of incorrect positions and poor posture.
- It is not recommended for use more than 3-4 hours per day.

Colour: ■ Beige.



E-240 Video

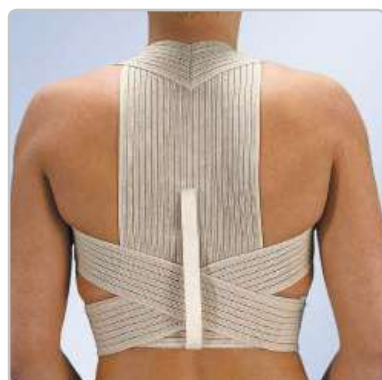

Ref.: ET-210

F .. C . S .. I ..

## BREATHABLE SHOULDER SUPPORT

SIZES	PERIMETER CM
1	75-85
2	80-92
3	85-97
4	92-104
5	98-110
6	104-120

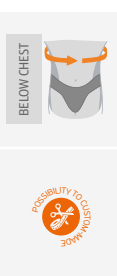

### Characteristics:

Wide dorsal band of breathable multi-band elastic fabric. Two upper bands are lengthened over the shoulders, pass under the arm, cross the back and fasten over the abdomen permitting gradual traction of the back through repulsion of the shoulders until the poor kyphotic posture is corrected.

### Indications:

- Dorsalgia.
- As corrector of incorrect positions and poor posture.
- Regulation of the dorsal position by postural effects and anatomic recall.
- It is not recommended for use more than 3-4 hours per day.

Colour: ■ Beige.



ET-210 Video





Ref.: ET-220

S .. C . E .. I ..

## BREATHABLE REINFORCED SHOULDER SUPPORT

SIZES	PERIMETER CM
1	75-85
2	85-105
3	105-130



### Characteristics:

Wide dorsal band of breathable multiband elastic fabric reinforced with 2 rigid paravertebral elements. Two upper elastic bands that extend over the shoulders and pass under the armpits, where it is reinforced with a double layer of fabric for greater comfort of use. These bands cross over at the back and fasten at the front, allowing gradual and individualised traction of the back through repulsion of the shoulders in order to reduce harmful kyphotic postures.

### Indications:

- Dorsalgia.
- Muscular imbalances.
- Constant stress.
- Kyphotic attitude.
- Slight spinal deviations.

Colour: ■ Beige.

### MAIN FEATURES



Reinforced with 2 semi-rigid paravertebral stays.



Reinforced area with a double layer of fabric for greater comfort of use.



Ref.: E-250

S .. C . E .. I ..

## COMFORT FIGURE-OF-EIGHT SHOULDER SUPPORT

SIZES	PERIMETER CM
1	75-85
2	85-105
3	105-130



### Characteristics:

Two bands composed of a breathable elastic foam fabric allow a perfect fit to the trunk. The orthosis provides adequate control of the thoracic area and shoulder girdle due to its wraparound circumferential design. Its cotton inner layer makes it very comfortable to wear and both bands are joined by an elastic that facilitates fitting. It has 2 posterior crossover straps that, when tightened, help to keep the spine correctly aligned in different postures (standing or sitting).

### Indications:

- Dorsalgia.
- Muscular imbalances.
- Constant stress.
- Kyphotic attitude.
- Slight spinal deviations.

Colour: ■ Beige.

### MAIN FEATURES



Breathable foamized fabric elastic, in the armpit area for more comfort.



Posterior crossover straps to help to keep the spine correctly aligned in different postures.



Both bands are joined by an elastic that facilitates fitting.

## MAIN FEATURES



**Threadless Seams.**  
Made of breathable multiband material.



**More aesthetic and ergonomic front design.** Fits better to the abdominal area.



At each end of the band, the fasteners have a pocket to accommodate the fingers, making it easier to fit.



TRUNK | HARNESES



Ref: **LTG-285**

**F** ... **C** ... **S** ... **I** ...

**LUMBOSACRAL BACK SUPPORT LUMBITRON ELITE**



**21 cm**

**SHORT MODEL**

Ref: **LTG-275**

**F** ... **C** ... **S** ... **I** ...

**SHORT LUMBOSACRAL BACK SUPPORT LUMBITRON ELITE**

### Ref: LTG-285

SIZES	PERIMETER CM	TROCHANTER	FRONT HEIGHT	BACK HEIGHT
1	75-85			
2	85-95		14 cm	26 cm
3	95-105			
4	105-115			
5	115-125			
6	125-135			
7	135-145			

### Characteristics:

Reinforced in the lower back region with four preformed steel stays, which are flexible and adaptable. The front part includes 2 flexible stays for improved consistency and abdominal restraint. Its inner part incorporates a foam lumbar pad which provides heat to the area, having a thermal effect, at the same time as providing selective compression in the lumbar region.

### Indications:

- Lumbago.
- Lumbosciatica.
- Degenerative processes.
- Atony and muscular weakness.
- Pre- and post-surgical treatment.

### Colour:

■ Grey.

### Components:

Belt + Foam lumbar pad.



### Ref: LTG-275

SIZES	PERIMETER CM	TROCHANTER	FRONT HEIGHT	BACK HEIGHT
1	75-85			
2	85-95		14 cm	21 cm
3	95-105			
4	105-115			
5	115-125			
6	125-135			
7	135-145			

## ACCESSORIES



Ref: **LTG-105**

**LUMBAR REINFORCEMENT**

The lumbar support can be ordered separately in the following sizes:

**LTG-105 LUMBAR REINFORCEMENT SIZES**

1 2 3 4 5 6



21 cm

SHORT MODEL

Ref: LTG-305

F ... C ... S ... I ...

SEMI-RIGID LUMBOSACRAL BACK SUPPORT LUMBITRON ELITE DUO

Ref: LTG-375

F ... C ... S ... I ...

SHORT SEMI-RIGID LUMBOSACRAL BACK SUPPORT LUMBITRON ELITE DUO

**Ref: LTG-305**

SIZES	PERIMETER CM	TROCHANTER	FRONT HEIGHT	BACK HEIGHT
1	75-85			
2	85-95		14 cm	
3	95-105			26 cm
4	105-115			
5	115-125			
6	125-135			
7	135-145			

**Characteristics:**

Reinforced in the lower back region with four preformed steel stays, which are flexible and adaptable. The front part includes 2 flexible stays for improved consistency and abdominal restraint. Its inner part incorporates a foam lumbar pad which provides heat to the area, giving a thermal effect, at the same time as providing selective compression in the lumbar region.

**Indications:**

- Lumbago.
- Lumbosciatica.
- Degenerative processes.
- Atony and muscular weakness.
- Pre- and post-surgical treatment.
- Disc herniation.
- Spondylolysis and spondyloarthritis.

**Colour:**  Grey.

**Components:**

Belt +Foam lumbar pad +Lumbar reinforcement.

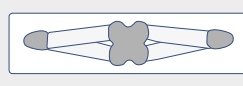

**Ref: LTG-375**

SIZES	PERIMETER CM	TROCHANTER	FRONT HEIGHT	BACK HEIGHT
1	75-85			
2	85-95		14 cm	
3	95-105			21 cm
4	105-115			
5	115-125			
6	125-135			
7	135-145			



## MAIN FEATURES



Flexible stays for improved stability



Finger loop for easy fitting.



Visco-elastic lumbar pad with pimpled surface for micromassage effect



Breathable stockinette



Greater elasticity on the edges for improved comfort



Ref.: 9201



Ref.: 9203

Ref.: 9201

F .. C ... S ... I ..

LUMBOSACRAL BACK SUPPORT WITH VISCO-ELASTIC PAD - UNISEX

Ref.: 9203

LUMBOSACRAL BACK SUPPORT WITH SEMI-RIGID STAYS - UNISEX

SIZES	PERIMETER CM	TROCHANTER
1	70-80	
2	80-90	
3	90-100	
4	100-110	
5	110-122	
6	122-135	

FRONT HEIGHT	BACK HEIGHT
16 cm	26 cm

### Characteristics:

Made from three-dimensional breathable stockinette, it features a visco-elastic lumbar pad with 38 micromassage pimples, pre-formed shape. Ref.: 9201 contains 2 flexible lumbar stays and 2 side stays. Ref.: 9203 contains 4 semi-rigid lumbar stays to provide greater stability to the girdle. Front closure with hook and velour on the abdominal plate with interior reinforcement, and a finger loop for easy fitting.

### Indications:

- Lumbago, chronic lumbar pain associated with degeneration, muscle and ligament insufficiency and after orthotic treatment with rigid corsets.
- As a prevention and protection method during sporting activities.

Colour:  Grey.

## ACCESSORIES



Ref.: AL070

VISCO-ELASTIC PAD

### Characteristics:

The therapeutic lumbar pad with pimpled surface enhances the function and effectiveness of the orthosis, and provides para-spinal musculature massage. Anatomically shaped.

Colour:  Blue.

SIZES

ONE SIZE



Ref.: LT-280 BEIGE

F .. C ... S ... I ..

## LUMBAR BACK SUPPORT

SIZES	PERIMETER CM	TROCHANTER	FRONT HEIGHT	BACK HEIGHT
1	63-75			
2	75-83		16 cm	26 cm
3	83-91			
4	91-99			
5	99-107			
6	107-115			
7	115-123			

### Characteristics:

Lumbosacral back support in multi-band breathable material with two crossed bands, vertical backstays and front Velcro fastening. The beige model incorporates a removable foam lumbar plate to provide heat to the lumbar area, which can easily be removed from the support when no longer necessary.

### Indications:

- Lumbago.
- Lumbosciatica.
- Degenerative processes.
- Weak and atonic muscles.
- Pre- and post-surgical treatment.

Colour: Beige.



Ref.: LT-283

F .. C ... S ... I ..

## LUMBAR BACK SUPPORT

SIZES	PERIMETER CM	TROCHANTER	FRONT HEIGHT	BACK HEIGHT
1	75-91			
2	91-115		16 cm	24 cm

### Characteristics:

Breathable multi-band material, 8 rear steel malleable stays, front velcro fastening.

### Indications:

- Lumbago.
- Lumbosciatica.
- Degenerative processes.
- Weak and atonic muscles.
- Pre- and post-surgical treatment.

Colour: Beige.



Ref.: LT-284  
BEIGE

Ref.: LTN-284  
BLACK

F .. C ... S ... I ..

## LUMBAR BACK SUPPORT "LUMBITRON STABLE"

SIZES	PERIMETER CM	TROCHANTER	FRONT HEIGHT	BACK HEIGHT
1	63-75			
2	75-83		16 cm	26 cm
3	83-91			
4	91-99			
5	99-107			
6	107-115			
7	115-123			

### Characteristics:

Elastic fabric, rear molded stays covered with imitation leather, Velcro fastening.

### Indications:

- Lumbago.
- Lumbosciatica.
- Degenerative processes.
- Weak and atonic muscles.
- Pre- and post-surgical treatment.

### Colours:

LT-284: Beige.  
LTN-284: Black.



Ref.: LT-290

F .. C ... S ... I ..

## HIGH LUMBAR BACK SUPPORT

SIZES	PERIMETER CM	TROCHANTER	FRONT HEIGHT	BACK HEIGHT
1	63-75			
2	75-83		20 cm	32 cm
3	83-91			
4	91-99			
5	99-107			
6	107-115			
7	115-123			

### Characteristics:

High lumbosacral support in multi-band breathable material with two criss-cross elastic bands, vertical backstays and Velcro front fastening. Incorporates a removable foam lumbar plate to provide heat to the lumbar area.

### Indications:

- Lumbago.
- Lumbosciatica.
- Degenerative processes.
- Weak and atonic muscles.
- Pre- and post-surgical treatment.

Colour: Beige.



Ref.: LT-300

F .. C ... S ... I ..

## REINFORCED LUMBAR BACK SUPPORT "FORTE"

SIZES	PERIMETER CM	TROCHANTER	FRONT HEIGHT	BACK HEIGHT
1	63-75			
2	75-83		16 cm	26 cm
3	83-91			
4	91-99			
5	99-107			
6	107-115			
7	115-123			

### Characteristics:

Semi-rigid lumbosacral support in multi-band breathable material with two crossed elastic tensor bands at the rear and fastening at the front, vertical backstays and front Velcro fastening. Incorporates a removable foam lumbar plate to provide heat to the lumbar area.

### Indications:

- Lumbago.
- Lumbosciatica.
- Muscular weakness.
- Degenerative processes.
- Disc hernia.
- Spondylolysis.
- Spondylarthrosis.

Colour: Beige.

Ref.: LT-303

F .. C ... S ... I ..

## REINFORCED UNIVERSAL LUMBAR BACK SUPPORT

SIZES	PERIMETER CM	TROCHANTER	FRONT HEIGHT	BACK HEIGHT
1	75-91			
2	91-115		16 cm	24 cm

### Characteristics:

Breathable multi-band material, 8 rear steel malleable stays, front velcro fastening. With elastic reinforcements to increase front to back compression.

### Indications:

- Lumbago.
- Lumbosciatica.
- Muscular weakness.
- Degenerative processes.
- Disc hernia.
- Spondylolysis.
- Spondylarthrosis.

Colour: Beige.

Ref.: LT-304  
BEIGE

Ref.: LTN-304  
BLACK

F .. C ... S ... I ..

## REINFORCED LUMBAR BACK SUPPORT "LUMBITRON STABLE FORTE"

SIZES	PERIMETER CM	TROCHANTER	FRONT HEIGHT	BACK HEIGHT
1	63-75			
2	75-83		16 cm	26 cm
3	83-91			
4	91-99			
5	99-107			
6	107-115			
7	115-123			

### Characteristics:

Elastic fabric, rear stays covered with imitation leather, lateral reinforcements, Velcro fastening.

### Indications:

- Lumbago.
- Lumbosciatica.
- Degenerative processes.
- Weak and atonic muscles.
- Pre- and post-surgical treatment.

### Colours:

LT-304: Beige.  
LTN-304: Black.

Ref.: LT-310

F .. C ... S ... I ..

## REINFORCED HIGH LUMBAR BACK SUPPORT

SIZES	PERIMETER CM	TROCHANTER	FRONT HEIGHT	BACK HEIGHT
1	63-75			
2	75-83		20 cm	32 cm
3	83-91			
4	91-99			
5	99-107			
6	107-115			
7	115-123			

### Characteristics:

High lumbosacral back support in multi-band breathable material, with two tensor elastic bands crossed at the rear and fastening at the front, vertical backstays and front Velcro fastening. Incorporates a removable foam lumbar plate to provide heat to the lumbar area.

### Indications:

- Lumbago.
- Lumbosciatica.
- Muscular weakness.
- Degenerative processes.
- Disc hernia.
- Spondylolysis.
- Spondylarthrosis.

Colour: Beige.



Ref.: LT-320

F .. C ... S ... I ...

## DORSO-LUMBAR BACK SUPPORT

SIZES	PERIMETER CM	TROCHANTER	FRONT HEIGHT	BACK HEIGHT
1	63-75			
2	75-83		20 cm	
3	83-91			54 cm
4	91-99			
5	99-107			
6	107-115			
7	115-123			

### Characteristics:

Lumbodorsal back support of breathable multi-band fabric with 4 rear stays combined with a dorsal piece extended by two bands that pass over the shoulders, under the arms, cross the back and fasten over the abdomen with Velcro bands.

### Indications:

- Spondylarthrosis.
- Weak and atonic muscles.
- Degenerative processes.
- Dorsalgia. Lumbalgias.
- Lumbosciaticas.

Colour: Beige.



Ref.: LT-330

F .. C .. S ... I ...

## REINFORCED DORSO-LUMBAR BACK SUPPORT

SIZES	PERIMETER CM	TROCHANTER	FRONT HEIGHT	BACK HEIGHT
1	63-75			
2	75-83		20 cm	
3	83-91			54 cm
4	91-99			
5	99-107			
6	107-115			
7	115-123			

### Characteristics:

Lumbodorsal support of breathable multi-band fabric with 4 rear stays combined with a dorsal piece extended by two bands that pass over the shoulders, under the arms, cross the back and fasten over the abdomen with Velcro.

### Indications:

- Protection of the dorsal and lumbar column.
- Painful scoliosis.
- Kyphosis.
- Lordosis.

Colour: Beige.

## ACCESSORIES ADAPTABLE TO THE LUMBITRON RANGE



Ref.: AL070

## VISCO-ELASTIC LUMBAR CUSHION

### Characteristics:

The therapeutic lumbar cushion improves the function and effectiveness of the orthosis, providing for massage on the para-vertebral musculature. Anatomically shaped.

Colour: Blue.

SIZES

ONE SIZE



Ref.: AL-060 BEIGE

## ANATOMIC LUMBAR CUSHION

### Characteristics:

Anatomic lumbar cushion mounted on a semi-rigid plastic plate, with a moldable adaptable strip and a velcro band at the rear, adaptable to all Lumbitron models; can be removed or attached as desired.

### Supply:

This cushion is optional and is supplied only by order. It's available with a height of 24 cm.

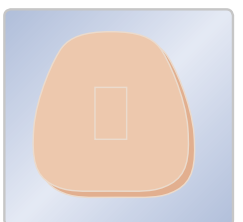

Ref.: NP-050

## FOAM LUMBAR CUSHION

### Characteristics:

The foam lumbar cushion provides heat to the lumbar area. When no longer necessary, cushion can be removed easily thanks to the incorporated velcro band.

Colour: Beige.

SIZES

ONE SIZE







Ref.: 6211

F .. C .. S .. I ..

### SHORT SACROLUMBAR BACK SUPPORT

Ref.: 6212

F .. C .. S .. I ..

### HIGH SACROLUMBAR BACK SUPPORT

SIZES	PERIMETER CM	TROCHANTER
1	80-90	
2	90-100	FRONT HEIGHT 18 cm (6211) 24 cm (6212)
3	100-110	BACK HEIGHT 28 cm (6211) 33 cm (6212)
4	110-120	
5	120-132	

#### Characteristics:

Made from a triple layer of fabric (cotton-foam-polyester) which is semi-rigid and perspirable, specifically designed for maximum transpiration. Easy-to-use, comfortable fastening system, allowing the Velcro to be personally adjusted to each patient.

#### Indications:

- Lower back pain.
- Degenerative processes.
- Weakness and muscular debility.
- Disc hernias.
- Post-surgery.

Colour: Beige.



Ref.: 6213

F .. C ... S ... I ...

### DORSOLUMBAR BACK SUPPORT

SIZES	PERIMETER CM	TROCHANTER
1	80-90	
2	90-100	FRONT HEIGHT 22 cm
3	100-110	BACK HEIGHT 51 cm
4	110-120	
5	120-132	

#### Characteristics:

Made from a triple layer of fabric (cotton-foam-polyester) which is semi-rigid and perspirable, specifically designed for maximum transpiration. Easy-to-use, comfortable fastening system, allowing the Velcro to be personally adjusted to each patient.

#### Indications:

- Dorsalgia.
- Degenerative processes.
- Weakness and muscular debility.
- Disc hernias.
- Post-surgery.

Colour: Beige.



Ref.: 6214

F .. C ... S .. I ..

### PENDULOUS ABDOMEN SACROLUMBAR BACK SUPPORT

SIZES	PERIMETER CM	ABDOMEN
1	90-100	
2	100-110	FRONT HEIGHT 26 cm
3	110-120	BACK HEIGHT 28 cm
4	120-132	
5	132-144	

#### Characteristics:

Made from a triple layer of fabric (cotton-foam-polyester) which is semi-rigid and perspirable, specifically designed for maximum transpiration. Easy-to-use, comfortable fastening system, allowing the Velcro to be personally adjusted to each patient. Front whalebones for greater consistency and abdominal support. Specifically designed with an anatomical shape for prominent abdomens.

#### Indications:

- Lower back pain.
- Degenerative processes.
- Weakness and muscular debility.
- Disc hernias and post-surgery.
- Prominent abdomens.

Colour: Beige.



Ref.: 6215

F .. C ... S ... I ...

### PENDULOUS ABDOMEN DORSOLUMBAR BACK SUPPORT

SIZES	PERIMETER CM	ABDOMEN
1	90-100	
2	100-110	FRONT HEIGHT 26 cm
3	110-120	BACK HEIGHT 51 cm
4	120-132	
5	132-144	

#### Characteristics:

Made from a triple layer of fabric (cotton-foam-polyester) which is semi-elastic and perspirable, specifically designed for maximum transpiration. Easy-to-use, comfortable fastening system, allowing the Velcro to be personally adjusted to each patient. The combined strips have a triple layer of perspirable material with an anatomical shape for perfect adaptation, with a Velcro fastening system elastic band at the end in order to obtain the required traction.

#### Indications:

- Dorsalgia.
- Degenerative dorsal processes.
- Weakness and muscular debility.
- Disc hernias and post-surgery.
- Efficient for use in people with a prominent abdomen.

Colour: Beige.



Ref.: FX-211

F ... C ... S ... I ...

### SEMI-RIGID LUMBAR BACK SUPPORT WITH VELCRO FASTENINGS

Ref.: FX-212

F ... C ... S ... I ...

### HIGH SEMI-RIGID LUMBAR BACK SUPPORT WITH VELCRO FASTENING

SIZES	PERIMETER CM	TROCHANTER
1	85-95	
2	95-105	
3	105-115	
4	115-125	
5	125-135	

SIZES	PERIMETER CM	FRONT HEIGHT
1	85-95	20 cm (FX-211) 25 cm (FX-212)
2	95-105	20 cm (FX-211) 25 cm (FX-212)
3	105-115	20 cm (FX-211) 25 cm (FX-212)
4	115-125	27 cm (FX-211) 32 cm (FX-212)
5	125-135	27 cm (FX-211) 32 cm (FX-212)

SIZES	PERIMETER CM	BACK HEIGHT
1	85-95	27 cm (FX-211) 32 cm (FX-212)
2	95-105	27 cm (FX-211) 32 cm (FX-212)
3	105-115	27 cm (FX-211) 32 cm (FX-212)
4	115-125	27 cm (FX-211) 32 cm (FX-212)
5	125-135	27 cm (FX-211) 32 cm (FX-212)

POSSIBILITY TO CUT TO SIZE

**Characteristics:**

Semi-rigid lumbosacral support made in semi-elastic cotton-rich fabric, easily adaptable rear anatomical stays, force-multiplier system by traction and adjustment straps and Velcro fastenings.

**Indications:**

- Lumbalgia and degenerative processes.
- Weak and atonic muscles.
- Disc hernias and postoperative care.
- The fastening system allows multiplication of the traction force and facilitates adjustment and positioning with the minimum effort.

**Colour:** Beige.



Ref.: FX-213

F ... C ... S ... I ...

### SEMI-RIGID DORSO-LUMBAR BACK SUPPORT WITH VELCRO FASTENING

SIZES	PERIMETER CM	TROCHANTER
1	85-95	
2	95-105	
3	105-115	
4	115-125	
5	125-135	

SIZES	PERIMETER CM	FRONT HEIGHT
1	85-95	23 cm
2	95-105	23 cm
3	105-115	23 cm
4	115-125	51 cm
5	125-135	51 cm

SIZES	PERIMETER CM	BACK HEIGHT
1	85-95	51 cm
2	95-105	51 cm
3	105-115	51 cm
4	115-125	51 cm
5	125-135	51 cm

POSSIBILITY TO CUT TO SIZE

**Characteristics:**

Lumbodorsal support made in semi-elastic fabric with anatomic rear stays, force multiplier system by traction and adjustment straps, Velcro fastening.

**Indications:**

- Dorsalgia and degenerative processes.
- Weak and atonic muscles.
- Disc hernias.
- Postoperative care.
- The fastening system allows multiplication of the traction force and facilitates adjustment and placement with minimum effort.

**Colour:** Beige.



Ref.: FX-214

F ... C ... S ... I ...

### SEMI-RIGID ABDOMEN PENDULUM LUMBAR BACK SUPPORT WITH VELCRO FASTENINGS

SIZES	PERIMETER CM	ABDOMEN
1	85-95	
2	95-105	
3	105-115	
4	115-125	
5	125-135	

SIZES	PERIMETER CM	FRONT HEIGHT
1	85-95	30 cm
2	95-105	30 cm
3	105-115	30 cm
4	115-125	32 cm
5	125-135	32 cm

SIZES	PERIMETER CM	BACK HEIGHT
1	85-95	32 cm
2	95-105	32 cm
3	105-115	32 cm
4	115-125	32 cm
5	125-135	32 cm

POSSIBILITY TO CUT TO SIZE

**Characteristics:**

Semi-rigid lumbar support made in semi-elastic cotton-rich fabric, easily adaptable rear anatomical stays, force-multiplier system by traction and adjustment straps and Velcro fastenings. With anatomic abdomen.

**Indications:**

- Lumbalgia. Degenerative processes. Weak and atonic muscles. Disc hernias. Postoperative care. Prominent abdomens.
- The fastening system allows multiplication of the traction force and facilitates adjustment and placement with minimum effort.

**Colour:** Beige.



Ref.: FX-215

F ... C ... S ... I ...

### SEMI-RIGID ABDOMEN PENDULUM DORSO-LUMBAR BACK SUPPORT WITH VELCRO FASTENINGS

SIZES	PERIMETER CM	ABDOMEN
1	85-95	
2	95-105	
3	105-115	
4	115-125	
5	125-135	

SIZES	PERIMETER CM	FRONT HEIGHT
1	85-95	30 cm
2	95-105	30 cm
3	105-115	30 cm
4	115-125	51 cm
5	125-135	51 cm

SIZES	PERIMETER CM	BACK HEIGHT
1	85-95	51 cm
2	95-105	51 cm
3	105-115	51 cm
4	115-125	51 cm
5	125-135	51 cm

POSSIBILITY TO CUT TO SIZE

**Characteristics:**

Semi-rigid lumbodorsal support made in semi-elastic cotton-rich fabric, easily adaptable rear anatomical stays, force-multiplier system by traction and adjustment straps and Velcro fastenings. Specially configured with anatomic form for prominent abdomens.

**Indications:**

- Dorsalgia and degenerative dorsal processes.
- Weak and atonic muscles.
- Disc hernias and postoperative care.
- Efficient for use in persons with prominent abdomens.
- The fastening system allows multiplication of the traction force and facilitates adjustment and positioning with the minimum effort.

**Colour:** Beige.



MAIN FEATURES



More ergonomic and functional design.



New closure system that makes fitting the back support easier and less strenuous for the hands.



Featuring lines that are much more anatomical to prevent any kind of chafing.

Front straps with rounded ends to prevent the front part of the back support from digging into the patient's abdomen when sitting.



Ref.: EV-100 GREY

Ref.: EV-200 BEIGE

Ref.: EV-300 BLACK

SEMI-RIGID LUMBAR BACK SUPPORT

F ... C ... S ... I ...

Ref.: EV-101 GREY

Ref.: EV-201 BEIGE

Ref.: EV-301 BLACK

HIGH SEMI-RIGID LUMBAR BACK SUPPORT

F ... C ... S ... I ...

SIZES	PERIMETER CM	Ref: EV-100 / EV-200 / EV-300		Ref: EV-101 / EV-201 / EV-301	
1	63-75	TROCHANTER		TROCHANTER	
2	75-83	FRONT HEIGHT		FRONT HEIGHT	
3	83-91	BACK HEIGHT		BACK HEIGHT	
4	91-99				
5	99-107				
6	107-115				
7	115-123				

■ Foam lumbar cushion colours:



NP-050: Beige.  
NP-051: Blue.  
NP-052: Black.

■ Characteristics:

Made from a dense elastic material which provides 50% more compression than those conventionally used for greater lumbar containment. Made with a threadless seam technique, avoiding bothersome rubbing. Reinforced in the lower back region with four preformed steel stays.

■ Indications:

- Lumbago.
- Lumbosciatica.
- Degenerative processes.
- Weak and atonic muscles.
- Pre- and post-surgical treatment.
- Disc hernia.
- Spondylarthrosis.
- Spondylolysis.
- Strong lumbosacral support, perfect anatomic fit, easy to use and soft on the skin.

■ Colour:

- EV-100: Grey.
- EV-200: Beige.
- EV-300: Black.



Ref.: EV-303 BLACK

Ref.: EV-203 BEIGE

F ... C ... S ... I ...

## ADAPTABLE DORSOLUMBAR MODULE DORSO EVOTEC

SIZES

ONE SIZE

### Adaptations:

The Evotec dorsolumbar module can also be used together with the sacrolumbar module in thermoplastic Evotec Forte, thus obtaining a higher degree of immobilization and stabilization of the thoracolumbar segment. Parts request must clip for unite both supports.

Ref.: EVS-MD



### Dorso Evotec®



### Characteristics:

Front side made of en transpirable honeycomb fabric and back made of soft boucle fabric. Built-in flexible steel stays, morphologically preformed to the dorsal zone. Elastic straps made of soft cushioned fabric, adaptable to adjust to the axilla zone and obtain greater comfort. New strap hook system with easy-to-close buckle. The dorsolumbar Dorso Evotec module is a single-size support which allows us to convert an Evotec lumbosacral orthosis into a thoracolumbosacral orthosis.

### Indications:

- Specially indicated in patients affected by kyphotic attitudes, vertebral wedging, dorsolumbar traumatism, infectious illnesses which affect the dorsal rachides, slipped disks, postoperative, osteoporosis and in all those cases in which the object is the correction of the kyphotic curve, and the antepulsion of shoulders.
- The dorsal module can always adapt upon an Evotec lumbrosacral support.

### Colour:

EV-203: ■ Beige.  
EV-303: ■ Black.

### Accessories:

Stays can be ordered with most rigid steel Ref: PALA-AINOX-FORM/2544.

### Dorso Evotec® Forte



Necessary to adapt the three parts.  
EVOTEC+DORSOEVOTEC+EVOTECFORTE

# Evotec® Forte ▶ Thermoplastic Module



Ref.: EVM-100  
BLUE (30cm)

Ref.: EVM-110  
BLUE (37cm)

F ... C ... S ... I ...

## LUMBOSACRAL MODULE IN THERMOPLASTIC

MODULE SIZES	BACK SUPPORT SIZES	RANGES	TROCHANTER
1	1-2	63-83	
2	3	83-91	
3	4-5	91-107	
4	6-7	107-123	HEIGHT  30 cm (EVM-100/200) 37 cm (EVM-110/210)

Equivalencies for finding the correct module for each Evotec Back Support.

### Characteristics:

Module made from low density polyethylene. Easy to fit for different body shapes. The upper tensor bands that go from the rear to the back can be fitted perfectly, even to body shapes that present large circumference differences between the hip and waist (men – women), as well as lifting the abdomen, an important characteristic for the orthotic treatment of the vertebral column. Perfect lateral immobilisation; the thermoplastic module is fixed onto the support by way of anchors. More aesthetically pleasing than other products on the market with these characteristics. Maximum immobilization with the completely fitted module, when the ailment diminishes, the outer module can be removed leaving a semi-rigid support

girdle.

### Indications:

- Degenerative disc conditions.
- Lumbar spondylarthrosis.
- Osteoporosis.
- Crushing.
- And in those cases where loading and lumbar vertebral movement is to be diminished.

### Colour:

EVM-100: ■ Blue. / EVM-110: ■ Blue.  
EVM-200: ■ Beige. / EVM-210: ■ Beige.

**MAIN FEATURES**



The aluminium plate\* can be moulded and allows for its length to be adjusted to obtain the correct height of the brace.



Ergonomic rigid straps for repulsion of shoulders. Its armpit protectors are properly fixed to stop them from moving.



Rotating joints, which help to adjust the brace to the correct position.



Locking system is designed with pins to make it a perfect fit.



**ACTIVE  
ADJUSTMENT  
TECHNOLOGY**



*Aluminium Plate: Patented System*

Three-layer breathable material at the rear:

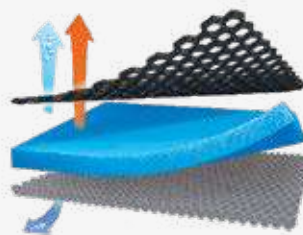

• Multi-cell foam fabric for greater resistance.



• Memory foam in the middle.



• Smooth towelling inside sweat absorption.



Ref.: TC300

F ... C ... S ... I ...

DORSOLUMBAR BRACE

SIZES	ONE SIZE
Height of the metal plate: 45-55 cm	
Abdominal perimeter: 70-130 cm	

**Characteristics:**

Lightweight and ergonomically designed dorsolumbar brace made from breathable materials for proper stabilisation and posture correction. The rear component is composed of a rigid fabric base and a height-adjustable aluminium plate. It provides an individualised fit to the curvature of the back thanks to its mouldability and properly controls the alignment of the spine. The front area features semi-rigid elements to increase intra-abdominal pressure and provide a stable base for posture correction. Both components are connected by a system of straps which, once adjusted (in position and traction), enables the kyphotic curvature characteristic of osteoporotic patients to be decreased.

**Effects:**

- Kyphotic curve correction, producing a slight increase in the patient's height.
- Stabilisation of the spine.
- Restriction of movements that may be harmful to the integrity of the vertebrae.
- Improved functional mobility, increasing the user's independence.
- Improved dynamic balance, preventing falls.
- Enables muscle activity.
- Increased intra-abdominal pressure.
- Pain relief, improving quality of life.

**Indications:**

- Stable osteoporotic fracture.
- Osteoporosis.
- Muscle weakness.
- Scheuermann's juvenile kyphosis.
- Kyphosis with back pain.
- Vertebral misalignments.
- Postural rehabilitation.

**Colour:**

- Grey.



UNISEX  
ONE SIZE



LIGHTWEIGHT AND  
DISCREET DESIGN



ANATOMICAL  
FIT



ERGONOMIC  
DESIGN

Aluminium Plate: Patented System

## MAIN FEATURES



Two silicone pads with relief points



Additional adjustment strap



Does not press on the organs or limit mobility



Ref.: SD80

F ... C .. S .. I ..

### SACROILIAC BELT WITH SILICONE PADS

SIZES	ONE SIZE	Perimeter min-max 90-135 cm	FRONT HEIGHT  8 cm
-------	----------	-----------------------------------	---

#### Characteristics:

Elastic belt offering support for the pelvis that provides constant and uniform pressure in cases of pain or instability. The elastic provides adequate support and the fastening can be adjusted using the additional adjustment strap. It protects the perineal area, does not press on the organs or limit mobility. Comfortable to wear, the strands of silicone inside prevent it from moving during use as they maintain correct position. In addition, it has 2 silicone pads with relief points that provide a pleasant massage effect to improve blood circulation and provide a pleasant feeling of comfort.

#### Indications:

- Lumbar, sacroiliac or pelvic pain.
- Weakness of the pelvic floor.
- Back pain.
- Ligamentous laxity/hypermobility.
- Prolapse or descent of pelvic organs (POP).
- Stress urinary incontinence.

#### Colour:

■ Grey.

## MAIN FEATURES



Sacroiliac compression pad



Drive system for pulleys





Regulation of the compression at will



Ref.: SD102

F ... C .... S ... I ...

### SACROILIAC BELT

SIZES	PERIMETER CM	TROCHANTER	FRONT HEIGHT	BACK HEIGHT
1	70-80			
2	80-95			
3	95-110		11 cm	
4	110-125			

#### Function:

Compression and stabilisation of the sacroiliac joint to suppress ligament-muscle reflexes and reduce muscle spasm in the back. It enables unrestricted freedom of movement, as it is more comfortable and smaller than conventional belts.

#### Characteristics:

A 17-cm wide pelvic belt made from velour and Poromax fabric, supplied with a sacroiliac pad made from foam and a hook closure system. Compression adjustment system by means of pulleys to enable maximum compression with the minimum of effort.

#### Indications:

- Sacroiliac joint injuries with or without inflammation.
- Sacroiliac joint sprain.
- Sacroiliac joint instability.
- Dynamic osteopathy of pubis (groin injury), trauma injuries to the pubic symphysis.

#### Colour:

■ Grey.

# Trusses



Ref.: O-104

F . . . . C . . . . S . . . . I . . . .

## NAVEL TRUSS

SIZES	PERIMETER CM	
7	73-83	
8	84-91	
9	92-99	
10	100-107	
11	108-120	

### Characteristics:

Elastic strap with rear Velcro fastening and interchangeable navel cushion.

### Indications:

- Reduction of umbilical hernias.
- Good compression on the navel area.

Colour:  Beige.



Ref.: O-105

F . . . . C . . . . S . . . . I . . . .

## NAVEL TRUSS

SIZES	PERIMETER CM	
1	70-95	
2	95-125	
3	125-150	

### Characteristics:

An elastic belt made of compressive, breathable fabric with an adjustable closure. Features a removable silicone cotton-lined pad. With semi-rigid vertical reinforcements for adequate adaptation and to prevent folding.

### Indications:

- To reduce umbilical hernias.

Colour:  White.



Ref.: B-110/D-111/I-112

F . . . . C . . . . S . . . . I . . . .

## REINFORCED TRUSS WITH VELCRO FASTENING

SIZES	PERIMETER CM	
7	70-78	
8	78-86	
9	86-94	
10	94-102	
11	102-110	
12	110-120	

### Characteristics:

Elastic belt with Velcro fastening, anatomic cushions extended with straps under the buttocks and fixed to the sides.

### Indications:

- Lateral reducible inguinal hernias (right or left) and bilateral (right and left).
- Compression and reduction of hernias, maximum containment and comfort.

Colour:  Beige.

### Models available:

- B-110: Bilateral.
- D-111: Right.
- I-112: Left.



Ref.: BH-110/DH-111/IH-112

F . . . . C . . . . S . . . . I . . . .

## REINFORCED TRUSS WITH BUCKLE FASTENING

SIZES	PERIMETER CM	
7	70-78	
8	78-86	
9	86-94	
10	94-102	
11	102-110	
12	110-120	

### Characteristics:

Elastic belt with buckle fastening, larger anatomic cushions than those of the truss with Velcro fastening, extended with straps under the buttocks and fixed to the sides.

### Indications:

- Lateral reducible inguinal hernias (right or left) and bilateral (right and left)
- Compression and reduction of hernias, maximum containment and comfort.

Colour:  Beige.

### Models available:

- BH-110: Bilateral.
- DH-111: Right.
- IH-112: Left.





# Trusses



Ref.: BS-110

Ref.: BB-100 BAG

F ... C ... S . I .

## SUSPENSORY TRUSS

REF: BB-100



SIZES	LENGTH (CM) BETWEEN A-C-B
1	25
2	27
3	29
4	31
5	33
6	35
7	37

REF: BS-110



SIZES	PERIMETER TROCHANTER CM
7	70-80
8	78-86
9	86-94
10	94-102
11	102-110
12	110-120

### Characteristics:

Truss with double elastic belt, straps under the buttocks with fastening on the side and interchangeable scrotal bag.

### Indications:

- In large scrotal hernias.

**Colour:** Beige.

### Models available:

BS-110: Truss belt.  
BB-100: interchangeable scrotal bag.

### Point of measurement of the bag:

Length in cm between the groins from A to B passing under the scrotum C.



S-120



S-121

Ref.: S-120 MAN

Ref.: S-121 WOMAN

F ... C ... S . I .

## HERNIA SLIP

SIZES
75
80
85
90
95
100
105
110
115
120



### Characteristics:

Slip made with fabric of varying elasticity at different points, two cushion, scrotal band holds the abdomen with Velcro fastening, easy placement and washing. Male and female versions.

### Indications:

- Inguinal hernias.
- Especially recommended in pre- and post-surgical processes.
- Uniform containment of the inguinal area.

**Colour:** Beige.

### Models available:

S-120: Man  
S-121: Woman.

# Containment truss



Ref.: S-130

F ... C ... S . I .

## GENITOURINARY PROLAPSE TRUSS

SIZES	UNIVERSAL

### Characteristics:

A truss that comprises of an abdominal band made from breathable elastic fabric to which containment straps are attached which extend from the buttocks area at the back to the stomach area at the front. Its function is to contain the genitourinary area by means of the Velcro straps which can be adjusted to suit the needs of the patient.

### Indications:

- Uterine prolapse.
- Cystocele.
- Vaginal vault prolapse.

\*All of them in their most serious and fullest stages of development.

**Colour:** Beige.

MAIN FEATURES



MORE  
LIGHTWEIGHT

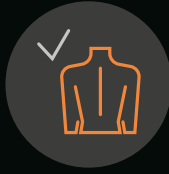

FUNCTIONAL



UPDATED  
COMFORTABLE DESIGN



LATEX-FREE

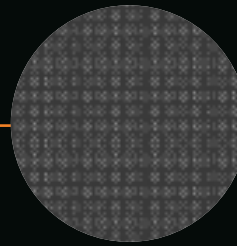

**Multi-cell foam fabric**  
All of the upper padding is made from foam fabric, thermoformed for greater comfort, and can be easily removed thanks to its Velcro fastening system.



**Closure system**  
Incorporating a concealed catch to enable the closure system to be released, and preventing it from accidentally opening due to friction or being knocked.

Patented model

3-AXIS MOVEMENT

3D

Three-Dimensional  
Adjustment  
Technology



Its revolutionary three-dimensional system provides movement on three axes thanks to pectoral hinges that ensure a snug fit to the chest and achieve a full elastic range.

This new, more comfortable system significantly improves the fit of the brace on the chest, without losing its functionality, and helps the patient tolerate the prescribed treatment much better.

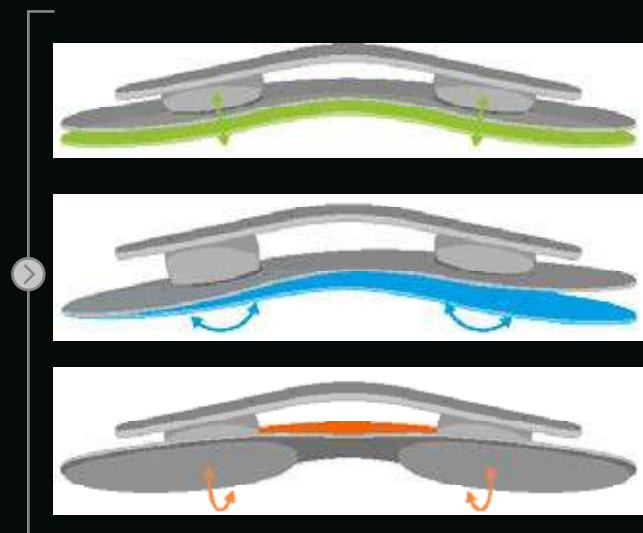



ARTICULATED

**Ref.: J001G | Ref.: J001AG ARTICULATED**

**JEWETT HYPEREXTENSION BRACE WITH THREE-DIMENSIONAL STERNAL ADJUSTMENT**

SIZES	PELVIC CIRCUMFERENCE	HEIGHT*
1	60-75	39-46
2	75-90	42-49
3	90-105	45-52
4	105-115	49-56

\*Between the sternal pad and the bottom of the pelvic band.



**Ref.: J002G | Ref.: J002AG ARTICULATED**

**JEWETT HYPEREXTENSION BRACE WITH THREE-DIMENSIONAL STERNAL ADJUSTMENT - SHORT**

SIZES	PELVIC CIRCUMFERENCE	HEIGHT*
2	75-90	39,5-43,5
3	90-105	42-49
4	105-115	45,5-52,5

\*Between the sternal pad and the bottom of the pelvic band.



**Characteristics:**

Hyperextension brace featuring 3 support points: suprapubic, dorsolumbar and sternal; a structure of lightweight alloy aluminium of the type used in the aeronautical industry; a more aesthetic updated design; and an innovative three-dimensional pectoral support system with 3-axis movement thanks to pectoral hinges that ensure a snug fit to the chest and achieve a full elastic range. This new, more comfortable support significantly improves the fit of the brace to the patient's body, minimising painful impacts that may influence the use of the orthosis for the prescribed treatment.

The articulating pelvic support provides the patient with greater comfort while seated and can be fixed at a specific angle. Its closure system is very secure, fast and easy to use. All of the upper padding is made from foam fabric, thermoformed for greater comfort, and can be easily removed thanks to its Velcro fastening system.

**Effects:**

- Hyperextension of the spinal column by means of a three-point support system.
- Mechanical discharge of the vertebral bodies in the lower thoracic and upper lumbar areas.
- Stabilisation and restriction of spinal movements.
- Pain relief.

**Indications:**

- Compression fractures.
- Vertebral pain caused by secondary metastasis.
- Spondyloarthritis associated or unassociated with arthroscopic sclerosis.
- Chronic lumbalgia, lumbosciatica and dorsalgia.
- Medium-term immobilisation after intervertebral disc surgery.
- Stable vertebral fractures of the lower dorsal spine and lumbar spine.
- Temporary orthotic care after unstable vertebral body fracture surgery.
- Permanent orthotic care after vertebral body tumour and metastasis surgery.
- Post-surgical care after decompression spine surgery with or without internal fixation.

**Colour:** ■ Grey.

**Models available:**

- J001G: Jewett Frame.
- J001AG: Articulated Model.
- J002G: Short Jewett Frame.
- J002AG: Short Articulated Jewett Frame.



**Dorsolumbar support**

Thanks to this system, the patient can opt for vertical or horizontal positioning for greater comfort.



Ref.: J001AG

The J001AG articulated model has been designed to enable the angle of the pectoral area to be set to 5 different positions in increments of 20°.



Pelvic support that can be set to 3 positions in increments of 20°.



## FASTENING SYSTEM

Refs: J001/J002 - Ref: J003/J004 incorporate a hidden trigger which frees and then opens the fastening system, avoiding involuntary opening due to any impact or friction on the fastening system.



Ref.: J001A

Ref.: J002A



Ref.: J001    Ref.: J002 SHORT

F ... C . S ..... I ....

## JEWETT FRAME

Ref.: J001A    Ref.: J002A SHORT

## ARTICULATED JEWETT FRAME

### Ref.: J001 / J001A

SIZES	PELVIC GIRTH	HEIGHT*
1	60-75	39-46
2	75-90	42-49
3	90-105	45-52
4	105-115	49-56

\*Between the sternal pad and the lower part of the pelvic strap.

### Ref.: J002 / J002 A

SIZES	PELVIC GIRTH	HEIGHT*
2	75-90	39'5-43'5
3	90-105	42-49
4	105-115	45'5-52'5

\*Between the sternal pad and the lower part of the pelvic strap.

### Models available:

J001: Jewett Frame.  
J001A: Articulated Jewett Frame  
J002: Short Model.

### Characteristics:

3 support points (pectoral, suprapubic, dorsal lumbar). Light aluminium structure. Mobile sternum plate. Height regulation at side control plate level. Dorsal lumbar tightening plate, adjustable via band and fastening system. Padded plates for greater comfort. The pelvic band can be fixed or rocking, to be adapted to different positions of the patient. A new model ( J001A) has been designed with a system to regulate chest support inclination with five adjustable positions at 20° intervals.

### Indications:

- Fractures due to crushing.
- Vertebral pain caused by secondary metastasis. Spondyloarthritis associated or not with arthritic sclerosis.
- Lumbalgia, lumbosciatica, and chronic dorsalgia.
- Stable vertebral fractures of the lower dorsal column and the lumbar column.
- Mid-term immobilisation after intervertebral disc surgery.
- Post-surgical care after spine surgery by decompression with or without internal attachment.

Colour:  White.

Ref.: J003    Ref.: J004 SHORT

F ... C . S ..... I ....

## JEWETT FRAME WITH PUBIC SUPPORT

### Ref.: J003

SIZES	PELVIC GIRTH	HEIGHT*
1	60-75	39-46
2	75-90	42-49
3	90-105	45-52
4	105-115	49-56

\*Between the sternal pad and the lower part of the pubic support.

### Ref.: J004

SIZES	PELVIC GIRTH	HEIGHT*
2	75-90	39'5-43'5
3	90-105	42-49
4	105-115	45'5-52'5

\*Between the sternal pad and the lower part of the pubic support.

### Characteristics:

3 support points (pectoral, suprapubic, dorsal lumbar). Light aluminium structure. Mobile sternum plate. Height regulation at side control plate level. Dorsal lumbar tightening plate, adjustable via band and fastening system. Padded plates for greater comfort with pubic support. The new locking system, with the buckle being fastened from back to front, easing the tension on the rear strap, making it easier to secure. There is a small hidden catch to release and open the lock, thereby preventing it from opening accidentally after a blow or after rubbing on the closure system.

Colour:  White.

### Models available:

J003: Jewett Frame.  
J004: Short Model.

## ACCESSORIES



Ref.: J100

## JEWETT CHEST SUPPORT UNIT

SIZES

ONE SIZE

### Features:

Consists of 2 individual padded supports linked to an adjustment strap to change the height and rotation.

### Indications:

Sternal support intolerance due to respiratory failure, pigeon chest, sternum fractures, chest asymmetries and others.

Colour:  White. / Units per pack: 2



Ref.: J101

## JEWETT AXILLARY PROTECTOR

SIZES

ONE SIZE

### Features:

Consists of 2 independent pads to prevent the frame irritating the underarm region.

Colour:  White. / Units per pack: 2



Ref.: LSO-B | Ref.: LSOC-B SHORT

F ... C ... S ... I ...

### LUMBOSACRAL RIGID CORSET

REFERENCE	VERSION	BACK HEIGHT	FRONT HEIGHT
LSO-B	UNISEX	39 cm	2= 26
			3= 27
			4= 27
			5= 28,5
LSOC-B	UNISEX	28,5 cm	2= 17
			3= 18
			4= 18
			5= 18,5

SIZES	PERIMETER CM	TROCHANTER
2	80-90	
3	90-100	
4	100-110	
5	110-120	

#### Plates:

Made in low density polyethylene that easily shapes itself to the dorsal curves, the thermomoldable plates can be shaped by an orthopaedic technician using a hot air gun.

#### Characteristics:

Twin shell corset formed by a front plate, a back plate with overlap areas on the side, all in thermoplastic and with strong lateral shaped stays. They are covered with strong external material and smooth internal ribbed fabric. The areas are joined together by a side zip and adjustable front-to-back straps, with distal zones of greater surface area and a small hook to attach to the front plate padding.

#### Indications:

- Disc hernias.
- Osteoporosis.
- Spondyloarthrosis.
- Spondylolysis with or without slip.
- Traumatism.
- Compression fractures.
- Degenerative disc disease.
- Postoperative fusion.
- Chronic muscular disease.
- Treatment of vertebral metastasis.
- The LSO-C model is especially indicated in patients who spend the majority of the time lying down.

#### Colour:

Beige.

#### Models available:

LSO-B: Lumbosacral orthosis.  
LSOC-B: Short lumbosacral orthosis.



Ref.: TLSO-B

F ... C ... S ... I ...

### THORACIC LUMBOSACRAL RIGID CORSET

REFERENCE	VERSION	BACK HEIGHT	FRONT HEIGHT
TLSO-B	UNISEX	51 cm	2= 26
			3= 27
			4= 27
			5= 28,5

SIZES	PERIMETER CM	TROCHANTER
2	80-90	
3	90-100	
4	100-110	
5	110-120	

#### Plates:

Made in low density polyethylene that easily shapes itself to the dorsal curves, the thermomoldable plates can be shaped by an orthopaedic technician using a hot air gun.

#### Characteristics:

The TLSO model has padded shoulder straps that force the shoulders upwards avoiding discomfort under the arms when attaching the guide straps. The distal ends of the straps have a small hook and can be adjusted to the height and width of the patient.

#### Indications:

- Disc hernias.
- Osteoporosis.
- Spondyloarthrosis.
- Spondylolysis with or without slip.
- Traumatism.
- Compression fractures.
- Degenerative disc disease.
- Postoperative fusion.
- Chronic muscular disease.
- Treatment of vertebral metastasis.

#### Colour:

Beige.



Ref.: EXTERNAL/LSO

### STERNAL SUPPORT/ LSO

SIZES	HIPS
LSO2	
LSO3	
LSO4	
LSO5	

The sternal support is designed as an accessory to the lumbosacral orthosis model LSO-B (Lumbar Star-Brace Corset), and can be adapted as necessary or as indicated.

#### Colour:

White.

Coincides with the size of each lumbosacral corset.



Ref.: SD100 | Ref.: SD101 HIGH

F ... C ... S ... I ...

## STAR BRACE® DYNAMIC SEMI-RIGID BACK SUPPORT

SIZES	PERIMETER CM	TROCHANTER
1	75-85	
2	85-95	
3	95-110	
4	110-125	

FRONT HEIGHT	BACK-HEIGHT
18 cm (SD100) 23 cm (SD101)	27 cm (SD100) 32 cm (SD101)



### Characteristics:

The Dynamic Star Brace back support is a semi-rigid lumbosacral orthosis made of a breathable bilayer material of Velour in polyamide and Poromax lining. This facilitates ventilation and moisture absorption, while also incorporating a unique antibacterial Thermo-tex treatment to prevent the growth of bacteria causing unpleasant smells. The lumbar area contains a thermoplastic stay within its inner padding while on the outside there is a thermoplastic frame with a string pulley system.

### Indications:

- Lumbago, sciatica, degenerative conditions, atony and muscular weakness, pre- and post-surgical treatments, herniated disc, spondylarthritis, spondylolysis.
- Firm lumbosacral support, fits perfectly to the body, comfortable for daily use.

### Colour:

■ Grey.

### Models available:

- SD100: Short Semi-Rigid Back Support.
- SD101: High Semi-Rigid Back Support.

### Components:



Back support



Thermoplastic pad



### PULLEY TRACTION SYSTEM

"Compression and limitation of lumbosacral mobility" adjustable via the pulley control system.



## STAR BRACE® DYNAMIC AND STAR BRACE® DYNAMIC FIX ACCESSORIES



Ref.: SD115

### STAR BRACE® DYNAMIC THERMOPLASTIC PLATE FOR PENDULOUS ABDOMENS



#### Characteristics:

As a replacement for the abdominal plates in Star Brace® Dynamic and Dynamic fix orthoses for use by patients with pendulous abdomens to ensure a more comfortable fit. Ref. SD115 is specially designed for patients with these morphological characteristics

#### Colour:

■ Black.

SIZES ONE SIZE



Ref.: SD103 | Ref.: SD104 HIGH

F ... C ... S ... I ...

## STAR BRACE® DYNAMIC FIX SEMI-RIGID CORSET

SIZES	PERIMETER CM	TROCHANTER	FRONT HEIGHT	BACK HEIGHT
1	75-85		18 cm (SD103) 23 cm (SD104)	30 cm (SD103) 38 cm (SD104)
2	85-95			
3	95-110			
4	110-125			

### Characteristics:

The Dynamic Fix Star Brace Dynamic Fix/corset is a rigid lumbosacral orthosis made of a breathable bilayer material of Velour in polyamide and Poromax lining. The lumbar area contains a moulded, low-density polyethylene thermoplastic module within its inner padding, which is attached via a textile cover that allows the module to be removed. There is also an abdominal compression plate incorporated. Contains a hook closure system. In addition, the module can be removed from the Dynamic Fix Star Brace Dynamic Fix/corset to leave a semi-rigid back support.

### Indications:

- Herniated discs, osteoporosis, spondyloarthritis, spondylolysis with or without stability, trauma, compression fractures, degenerative disc disease, post-operative fusion, chronic muscle illness, treatment of vertebral metastasis.

### Colour:

■ Grey.

### Models available:

- SD103: Short Semi-Rigid Corset.
- SD104: High Semi-Rigid Corset.



### Components:



### MAIN FEATURES

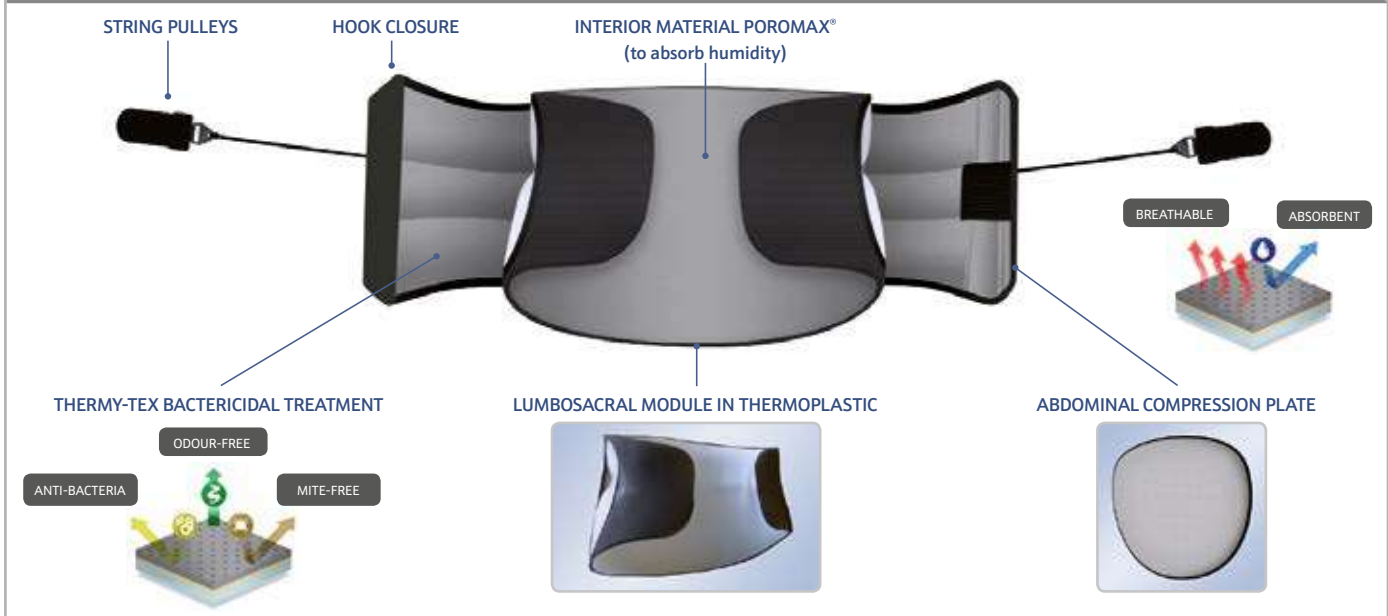

### REPLACEMENTS PARTS FOR STAR BRACE® DYNAMIC AND STAR BRACE® DYNAMIC FIX



Ref.: SD110

THERMOPLASTIC LUMBOSACRAL MODULE

For model SD103

SIZES	1	2	3	4
For braces of the same size. Height 30 cm.				



Ref.: SD111

WIDE THERMOPLASTIC LUMBOSACRAL MODULE

For model SD104

SIZES	1	2	3	4
For braces of the same size. Height 38 cm.				



Ref.: SD112

ABDOMINAL COMPRESSION PLATE

SIZES ONE SIZE



Ref.: SD113

THERMOPLASTIC PAD

Size 1 for model SD100 / Size 2 for model SD101

SIZES	1	2
HEIGHT	27 cm	32 cm



Ref.: **KC201** BEIGE



Ref.: **KC101** GREY



Ref.: **KC200A** ABDOMEN PENDULUM

## KNIGHT CORSET

F •••• C •••• S •••• I ••••

### Characteristics:

Lumbar sacral orthosis made from breathable honeycomb fabric and terrycloth. Its interior consists of a rigid structure of malleable aluminium and transversal stays to enable adjustment of lumbar lordosis if necessary. The front section is elasticated to enable the abdominal pressure to be adjusted to the physical characteristics of each patient. Closure is by means of a Velcro system located at the front. Patients with prominent abdomens are recommended to use the pendulous abdomen model to ensure greater comfort.

### Indications:

• Indicated for patients with lumbosacral injuries requiring immobilisation of this area of the spine to enable treatment, such as vertebral wedging, lumbar trauma, hernias, postoperative care, osteoporosis and vertebral fractures. Lumbago requiring temporary immobilisation.

### Colour:

Ref.: KC201: ■ Beige.

Ref.: KC101: ■ Grey.

Ref.: KC200A: ■ Beige.

### Ref.: KC201 / KC101

SIZES	PERIMETER CM	TROCHANTER	FRONT HEIGHT	BACK HEIGHT
2	80-90			
3	90-100		20 cm	
4	100-110			32 cm
5	110-120			

### Ref.: KC200A

SIZES	PERIMETER CM	TROCHANTER	FRONT HEIGHT	BACK HEIGHT
2	90-100			
3	100-110		25 cm	
4	110-120			28 cm
5	120-130			





# Modular dorso-lumbar Taylor orthosis

► Lumbosacral Orthosis



TRUNK | HARNESES



Ref.: TC101 GREY



Ref.: TC201 BEIGE



Ref.: TC200A ABDOMEN PENDULUM

## MODULAR DORSO-LUMBAR TAYLOR ORTHOSIS

F ... C ... S ... I ...

### Characteristics:

The lumbar and dorsal elements are made from breathable honeycomb fabric with terrycloth interior. The dorsal element features preformed malleable aluminium splints and adjustable semi-elastic straps in a soft padded fabric to fit the underarm area and achieve optimum comfort. The lumbosacral element features a belt with a lumbar structure and rear stays.

On their inner edge, from where they start on the dorsal side up to the shoulders, the straps are made with a more rigid edging to ensure a better fit for the dorsal element, thus enabling greater elasticity in the underarm area.

### Indications:

- Especially indicated in cases of kyphosis, vertebral wedging, dorso-lumbar injuries, infectious diseases that affect the dorsal spine, spinal disc herniation, post-operative care, osteoporosis, vertebral fractures and in all cases in which correction of kyphotic curvature is required.
- Certain low lumbago-associated dorsalgia (T8, T12) that requires temporary immobilisation (patient journeys, mechanical, work-related and domestic stresses and strains, etc.). In cases where partial thoracic containment is required at certain times of the day depending on the activity.
- A model is available for patients with pendulous abdomens (Ref.:TC200A).

### Colour:

Ref.: TC201: Beige.

Ref.: TC101: Grey.

Ref.: TC200A: Beige.

### Ref.: TC201 / TC101

SIZES	PERIMETER CM	TROCHANTER	FRONT HEIGHT	BACK HEIGHT
2	80-90			
3	90-100		20 cm	
4	100-110			47 cm min. 60 cm max.
5	110-120			

### Ref.: TC200A

SIZES	PERIMETER CM	WAIST	FRONT HEIGHT	BACK HEIGHT
2	90-100			
3	100-110		25 cm	
4	110-120			47 cm min. 55 cm max.
5	120-130			



Ref.: CT1001  
MAN

Ref.: CT1002  
WOMAN

F •••• C •••• S •••• I ••••

## TWIN SHELL CORSET

MAN	HIP	WAIST	BELOW CHEST
1	71-81	51-71	66-78
2	81-91	71-81	78-90
3	91-101	81-91	90-102
4	101-114	91-101	102-114
5	114-127	101-114	114-128

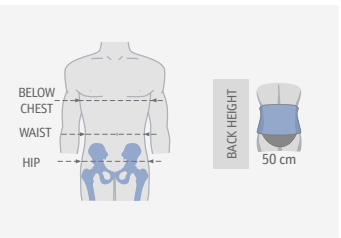

WOMAN	HIP	WAIST	BELOW CHEST
1	71-81	46-56	58-68
2	81-91	56-66	68-78
3	91-101	66-76	78-88
4	101-114	76-86	88-98
5	114-127	86-96	98-108

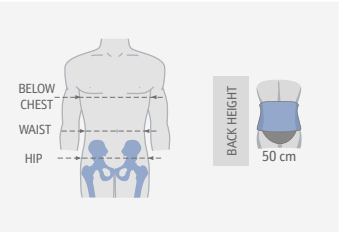

The sternum support height and depth can be adjusted by doubling the frontal splint, which allows us to properly adjust it according to each patient's physical characteristics.



### Characteristics:

Thoracolumbosacral corset made of 4 mm low-density polyethylene and lined with a padded fabric that can be easily removed, allowing it to be washed and thus achieving proper hygiene of the orthosis while simultaneously protecting the patient from possible chafing. A padded, height-adjustable splint is located on the front section, allowing us to achieve a complete extension of the spinal column. Polyethylene is a thermo-moldable material, allowing us to make adjustments on the corset by applying heat (the fabric lining must be removed before applying heat). The frontal plane is located from the sternum to the pubic symphysis; the breast area remains free on women. The rear plane is located from the middle third of the scapula to the halfway point of the gluteus region.

The Orliman twin shell corset features 15° of lumbar lordosis.

It is fastened with dobbies and Velcro straps at the iliac crests, waist, and underarms.

The sternum support height and depth can be adjusted by doubling the frontal splint, which allows us to properly adjust it according to each patient's physical characteristics. One of the main advantages of its design is that it facilitates placement on bedridden patients.

### Indications:

- Conditions that require immobilization of the spinal or lumbar areas, such as pre and post-op spinal procedures.
- Vertebral fractures.
- Herniated disc.
- Osteoporosis.
- Spondylolysis, spondylolisthesis, spondyloarthropathy, painful scoliosis in adults, etc.
- Torn or lax ligaments.
- Neoplasia that causes degenerative processes in the spine.
- Thoracic Kyphosis in mid to lower spinal region.
- Prevention of spinal stenosis in bedridden patients.

■ **Colour:** ● Grey.

## ACCESORIES



Ref.: CC2701

### KIT ALUMINIUM PLATES

SIZES

ONE SIZE

### Characteristics:

Aluminium plates for: CC2503 / CC2504 / CC2600 y corsés CT1001 / CT1002.

■ **Colour:** ● Black.



Ref.: 1000

F .... C .. S .... I ....

JACKET HARNESS WITH ZIP

SIZES	PERIMETER CM	
0	64-138	 TOTAL CIRCUMFERENCE OF PERSON AND SEAT OR CHAIR 
1	79-168	
2	89-178	

Characteristics:

Made from a triple layer of breathable semi-rigid material (polyamide, foam and polyester), it has regulation and securement straps with colour-coded buckle fasteners to facilitate positioning. The pectoral zone has a zip to facilitate the positioning of the jacket harness, allowing for adaptation without undoing the securement straps.

Indications:

- Suitable for patients with anterolateral instability, and can be adapted to wheelchairs and other types of chairs and seats, including car and other transport seats.

Colour: ■ Blue.



Ref.: 1001

F .... C .. S .... I ....

JACKET HARNESS

SIZES	PERIMETER CM	
1	79-168	 TOTAL CIRCUMFERENCE OF PERSON AND SEAT OR CHAIR 
2	89-178	

Characteristics:

Made from a triple layer of breathable semi-rigid material (polyamide, foam and polyester), it has regulation and securement straps with colour-coded buckle fasteners to facilitate positioning.

Indications:

- Suitable for patients with anterolateral instability, and can be adapted to wheelchairs and other types of chairs and seats, including car and other transport seats.

Colour: ■ Blue.



Ref.: 1002

F .... C .. S .... I ....

JACKET HARNESS WITH PERINEUM PIECE

SIZES	PERIMETER CM	
1	79-168	 TOTAL CIRCUMFERENCE OF PERSON AND SEAT OR CHAIR 
2	89-178	

Characteristics:

Made from a triple layer of breathable semi-rigid material (polyamide, foam and polyester), it has regulation and securement straps with colour-coded buckle fasteners to facilitate positioning. It comprises an abdominal belt attached to a bib with shoulder pads and a perineum strap, and on the ends there is a nylon dobbie with a slide and a fastening system to regulate the required securement.

Indications:

- Suitable for patients with anterolateral instability and a tendency to slide out of the seat, and can be adapted to wheelchairs and other types of chairs and seats, including car and other transport seats.

Colour: ■ Blue.



Ref.: 1003

F .... C .. S .... I ....

LEG ABDUCTOR HARNESS

SIZES	THIGH CIRCUMFERENCE CM	
0	27-37	
1	60-75	
2	65-80	

Characteristics:

Made from a triple layer of breathable semi-rigid material (polyamide, foam and polyester), it has a lumbar plate with belts and buckles for fixing in the chair back, belts passing under the buttocks towards the perineum, holding the thighs from the interior towards the hips. The thigh straps start at the inferior ends, with ratchet belts at the ends, and buckles and adjusters to fasten and adjust.

Indications:

- Suitable for patients who need to keep both legs in permanent abduction.

Colour: ■ Blue.



Ref.: 1004

F ... C .. S ... I ...

ABDOMINAL BELT

SIZES	PERIMETER CM	<p>TOTAL CIRCUMFERENCE OF PERSON AND SEAT OR CHAIR</p>
1	86-164	
2	96-174	

Characteristics:

Made from a triple layer of breathable semi-rigid material (polyamide, foam and polyester), it has regulation and securement straps with colour-coded buckle fasteners to facilitate positioning. This has a pelvic belt with a perineum strap which secures the patient to the wheelchair or other type of chair or seat, allowing full freedom of movement in the dorsal cervical zone.

Indications:

- Suitable for patients with good anterolateral control whilst seated but with a tendency to slide out of the seat.

Colour: ■ Blue.



Ref.: 1004A

F ... C .. S ... I ...

OPEN-ABDOMINAL BELT

SIZES	PERIMETER CM	<p>TOTAL CIRCUMFERENCE OF PERSON AND SEAT OR CHAIR</p>
0 (child)	35-190	
1	54-190	

Characteristics:

Made of a breathable triple layer of semi-rigid material (nylon, foam and polyester). It has securing straps with buckle closures, colour coded for easy fitting. It consists of a pelvic belt (with opening at the centre) that secures the patient to a wheelchair or other method of seating, allowing full freedom of movement in the dorsal cervical area.

Indications:

- Suitable for patients with good anterolateral control whilst seated but with a tendency to slide out of the seat.

Colour: ■ Blue.



Ref.: 1005

F ... C .. S ... I ...

ABDOMINAL BELT AND PERINEUM PIECE

SIZES	PERIMETER CM	<p>TOTAL CIRCUMFERENCE OF PERSON AND SEAT OR CHAIR</p>
1	94-182	
2	104-192	

Characteristics:

Made from a triple layer of breathable semi-rigid material (polyamide, foam and polyester), it has regulation and securement straps with colour-coded buckle fasteners to facilitate positioning. The pelvic belt with perineum strap secures the patient to the wheelchair or other type of chair or seat, but at the same time allows full freedom of movement in the dorsal cervical zone.

Indications:

- Suitable for patients with good anterolateral control whilst seated but with a tendency to slide out of the seat.

Colour: ■ Blue.



Ref.: 1007

F ... C .. S .. I ...

WRIST HARNESS

SIZES	ONE SIZE

Characteristics:

Made from a triple layer of breathable semi-rigid material (polyamide, foam and polyester), it has regulation and securement straps with buckle fasteners.

Indications:

- Suitable for patients who need to be completely secured to the bed, seat or chair, preventing free movement of the hands, which can be fixed in a relaxed or firm way, for one or both hands.

Colour: ■ Blue.



Ref.: 1008

F ... C .. S .. I ...

ANKLE HARNESS

SIZES	ONE SIZE	

Characteristics:

Made from a triple layer of breathable semi-rigid material (polyamide, foam and polyester), it has regulation and securement straps with buckle fasteners.

Indications:

- Suitable for patients who need to be completely secured to the bed, seat or chair, preventing free movement of the ankles, which are kept relaxed or firm, which can be fixed in a relaxed or firm way, for one or both ankles.

Colour: ■ Blue.

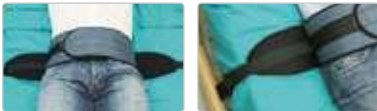

Ref.: 1011

F ... C ... S ... I ...

**BED SECUREMENT HARNESS**

SIZES	PERIMETER CM
1	70-115
2	115-140



WAIST CIRCUMFERENCE



For beds up to 150cm wide.

**Characteristics:**

Made from a triple layer of breathable semi-rigid material (polyamide, foam and polyester), it has regulation and securement straps with colour-coded buckle fasteners to facilitate positioning. It comprises 2 superimposed strips with nylon dobbies.

**Indications:**

• Suitable for bedridden patients who require securement to prevent falls or unwanted absence from the bed, allowing the patient to make quarter turns to the left or right, therefore preventing any falls.

**Colour:**  Blue.



Ref.: 1010

F ... C ... S ... I ...

**HARNESS WITH MAGNETS**

SIZES	PERIMETER CM
0	50-70
1	70-115
2	115-140



WAIST CIRCUMFERENCE



For beds up to 150cm wide.



The Arnetec-Fix magnetic fastener system is made up of 3 components:

- 1- The metal rod with groove for fastening.
- 2- Fixing button with anti-opening mechanism.
- 3- Magnetic release device for opening.

**Characteristics:**

Patients with alteration of physical or mental faculties who require partial or total securement to limit or impede movements of upper and lower limbs and trunk in order to prevent falls, pulling on drip feeds or absences from the bed. Manufactured in polyester 100% and cushioned textured lining inside, the pelvic belt has metal slides to attach the straps which regulate the range of rotation of the patient. The magnetic fastener systems adapted to these harnesses allow for quick and convenient placement of the device, whilst preventing manipulation by the patient or unauthorised persons.

**Indications:**

• Suitable for bedridden patients who require a control of their mobility and restraint in the bed, whilst allowing small rotational changes of posture to the left or right.

**Colour:**  White.



Ref.: 1013

F ... C ... S ... I ...

**HARNESS WRIST TO BELT WITH MAGNETS**

SIZES	ONE SIZE
-------	----------



**Characteristics:**

Manufactured in polyester 100% and cushioned textured lining, with system of magnetic closing, facilitating the rapid and comfortable fitting of the equipment, designed to be used with the trunk harness.

**Indications:**

• As an addition to the trunk harness, it is suitable for patients which need to be restrained completely to the bed, controlling the degree of freedom of the hands: complete immobilisation, limited range, one hand or both.

**Colour:**  White.



Ref.: 1014

F ... C .. S .. I ...

HARNESS WRIST TO BED WITH MAGNETS

SIZES ONE SIZE



**Characteristics:**  
Manufactured in polyester 100% and cushioned textured lining, with system of magnetic closing, facilitating the rapid and comfortable fitting of the equipment, and preventing manipulation by the patient or unauthorised persons.

**Indications:**  
· Suitable for bedridden patients who require an independent restriction of the hands, controlling the degree of freedom of the hands: complete immobilisation, limited range, one hand or both.

**Colour:**  White.



Ref.: 1015

F ... C .. S .. I ...

HARNESS ANKLE TO BED WITH MAGNETS

SIZES ONE SIZE



**Characteristics:**  
Comprising a belt which fixes to the bed, and two independent ankle belts. Manufactured in polyester 100% and cushioned textured lining, with system of magnetic closing, facilitating the rapid and comfortable fitting of the equipment, and preventing manipulation by the patient or unauthorised persons.

**Indications:**  
· Suitable for bedridden patients who require an independent restriction of the ankles, controlling the degree of freedom of the legs: complete immobilisation, limited range, one leg or both.

**Colour:**  White.



Ref.: 1017

F ... C ... S .. I ...

ABDOMINAL MAGNET HARNESS FOR CHAIR OR ARMCHAIR WITH BUCKLES

SIZES	CONTOUR WAIST CM	HEIGHT
1	70-115	13 cm
2	115-140	

Back support for chair or armchair from 30 cm to 80 cm, with extender (included) for chairs up to 130 cm.



Ref.: 1018

F ... C ... S .. I ...

ABDOMINAL MAGNET HARNESS FOR CHAIR OR ARMCHAIR

SIZES	CONTOUR WAIST CM	HEIGHT
1	70-115	13 cm
2	115-140	

Back support for chair or armchair from 40 cm to 75 cm, with extender (included) for chairs up to 120 cm.

ACCESSORIES

Ref.: 1100

PROLONGATION STRAP



**Characteristics:**  
Prolongation strap if needed for a wider seat, chair or bed (minimum 9 cm, maximum prolongation 85 cm). Except models magnets.

**Colour:** ■ Blue.  
**Packaging:** 1 unit.

Ref.: 1101

MAGNETIC BUTTON FOR THE HARNESS WITH MAGNETS



For models with magnets:  
**Colour:** ■ Blue.  
**Packaging:** 1 unit.

Ref.: 1102

MAGNETIC KEY FOR THE HARNESS WITH MAGNETS



For models with magnets:  
**Colour:** ■ Blue.  
**Packaging:** 1 unit.

Ref.: 1103

SAFETY PIN TO PREVENT SLIDING ON THE STRAPS ON THE HARNESSES

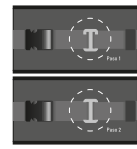

**Size:** One Size.  
**Packaging:** 3 unit.







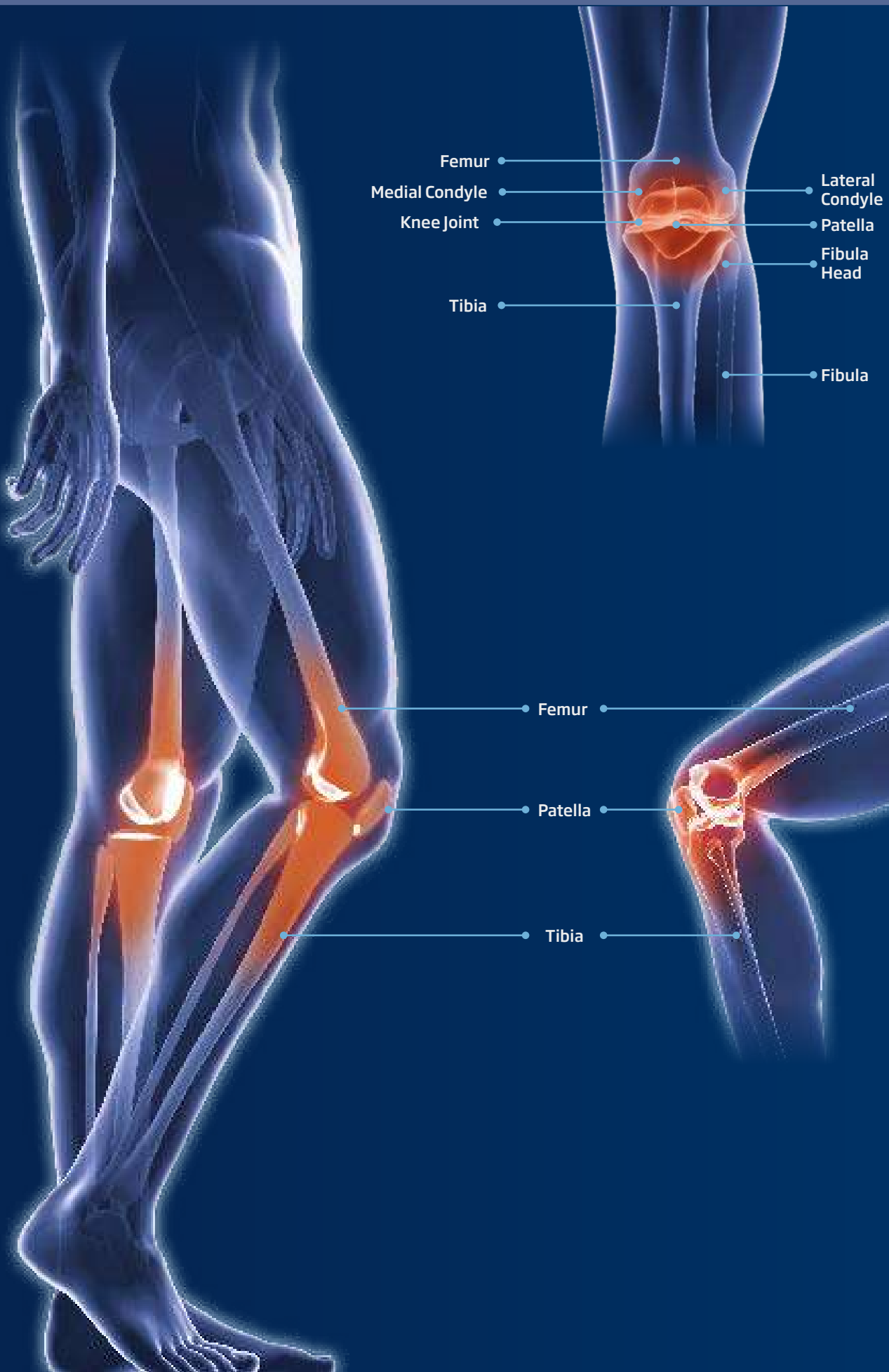



## MAIN FEATURES

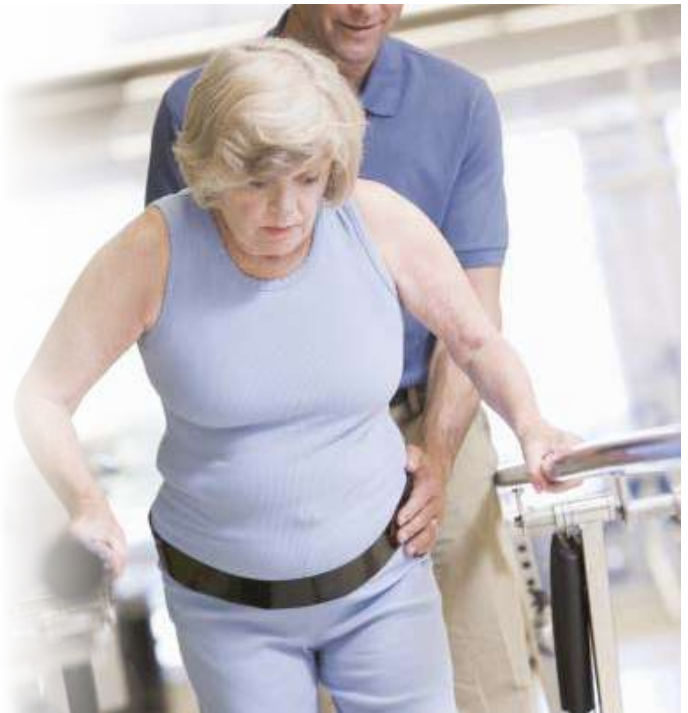

Ref.: HO4001

F . . . . C . . . . S . . . . I . . . .

### HIP STABILIZING ORTHOSIS

SIZES	WAIST CONTOUR	THIGH CONTOUR	FITTING
11D	60-102	40-54	Right
12D	60-102	50-64	Right
11I	60-102	40-54	Left
12I	60-102	50-64	Left
21D	90-132	40-54	Right
22D	90-132	50-64	Right
21I	90-132	40-54	Left
22I	90-132	50-64	Left

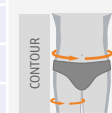

#### Characteristics:

Modular hip stabilizing orthosis that can be used interchangeably for the left or right hip. Made of high-density polyethylene. Comprised of a pelvic band and thigh support (both twin shell), connected by a joint that adjusts flexo-extension from 0° to 90° in increments of 10°, and abduction, in the 0°, 15° and 30° positions.

The thigh support allows you to modify the rotation and height of the condyle pad for a perfect fit. Both the pelvic band and the thigh support slide along the length of the joint splints in order to adapt them to the patient's height. The thigh support straps are made up of two velcro straps, and the pelvic band is adjusted using a Velcro belt.

The interior foam and external velour lining cover the plastic of the orthosis, protecting the patient from possible chafing from its rigid parts. These fabrics are easy to remove and wash, allowing for proper hygiene of the orthosis.

#### Indications:

- Post-op stabilization after full hip replacement.
- Complications after hip arthroplasty or dislocation.
- Post-reduction of dislocated or unstable prosthesis.
- After femoral head resection.
- Fractures.
- Poor bone quality (osteoporosis).

#### Colour:

■ Grey.



MAIN FEATURES

AREAS WITH DIFFERENT STITCHING FOR SELECTIVE ADJUSTMENT

At the top, the compression is less.

High elasticity for easier fitting and removal.

Three-dimensional knitted fabric, elastic and breathable, for proper fitting to the shape of the knee.

With viscoelastic padding inside, giving the patient an intermittent massage. The material is softer in the popliteal area.

The material is softer in the popliteal area.

At the bottom, the compression is less.

Flexible stabilisers inserted at the side to prevent folding, allowing the brace to move smoothly and improving mediolateral control.

- High tension dual elastomer.
- Multifilament containment.
- Dual elastomer.
- Multifilament.
- Dual elastomer.

LOWER LIMBS



Ref.:9104



Ref.:9105

Ref.: 8104 BEIGE | Ref.: 9104 BLACK

F .. C ... S .. I ..

CLOSED PATELLA KNEE BRACE W/SILICONE PAD & LATERAL FLEXIBLE REINFORCEMENTS

Ref.: 8105 BEIGE | Ref.: 9105 BLACK

F .. C ... S .. I ..

OPEN PATELLA KNEE BRACE W/SILICONE PAD & LATERAL FLEXIBLE REINFORCEMENTS

SIZES	PERIMETER CM A	PERIMETER CM B
1	38-41	28-31
2	41-44	31-34
3	44-47	34-37
4	47-50	37-40
5	50-53	40-43
6	53-56	43-46
7	56-59	46-49



Characteristics:

Developed using three-dimensional knitted fabric, providing greater transversal elasticity at the same time as it exerts the necessary compression in each area, this new knitted fabric concept provides better hold on the skin and stability during movement, and does not require any fastening system, incorporates a visco-elastic cushion in ring form which manages the kneecap control, with blockage, in an upper and lower lateral sense. Incorporates lateral stabilisers on both sides which prevent it rolling up and give a greater medio-lateral control.

Indications:

- Irritation (tendomyopathy, first phase ligamentosis, mild arthrosis, post-traumatic and postoperative arthritis).
- Sensation of instability (patellar and/or medio-lateral).

Colours:

- 8104: Beige.
- 9104: Black.
- 8105: Beige.
- 9105: Black.



Ref.:9106



Ref.:9107

Ref.: 8106 BEIGE | Ref.: 9106 BLACK

F .. C ... S ... I ..

**CLOSED PATELLA KNEE BRACE W/ SILICONE PAD & POLYCENTRIC REINFORCEMENTS**

Ref.: 8107 BEIGE | Ref.: 9107 BLACK

F .. C ... S ... I ..

**OPEN PATELLA KNEE BRACE W/ SILICONE PAD & POLYCENTRIC REINFORCEMENTS**

SIZES	PERIMETER CM A	PERIMETER CM B
1	36-39	26-29
2	39-42	29-32
3	42-45	32-35
4	45-48	35-38
5	48-51	38-41
6	51-54	41-44
7	54-57	44-47



Incorporates lateral metallic reinforcements to improve medio-lateral stabilisation. These reinforcements have a polycentric articulation with a minimum flexion of 7 degrees to prevent hyperextension of the knee and to avoid genurecurvatum.

**Characteristics:**

Developed using three-dimensional knitted fabric, providing greater transversal elasticity at the same time as it exerts the necessary compression in each area, this new knitted fabric concept provides better hold on the skin and stability during movement, and does not require any fastening system, incorporates a visco-elastic cushion in ring form which manages the kneecap control, with blockage, in an upper and lower lateral sense.

**Indications:**

- Episodes of irritation (tendomyopathy, first phase ligamentosis, mild arthrosis, post-traumatic and post-operative arthritis).
- Sensation of instability (patellar and/or medio-lateral).
- Correction of mild genu-recurvatum; also indicated for the correction of varus-valgus of the knee, linked with instabilities of the knee.

**Colours:**

- 8106: ● Beige.
- 9106: ● Black.
- 8107: ● Beige.
- 9107: ● Black.



Ref.: SP110

F .. C ..... S ... I .

**PATELLAR KNEE BAND**

SIZES	ONE SIZE
Knee perimeter range: 26-45 cm	



Compression, absorption and micro-massage effect are some of the improvements which we achieve thanks to the silicone cushion, contrary to other materials used previously.

**Characteristics:**

The patella support is made from velour and foam and incorporates a silicone ball which can be fastened and unfastened thanks to its micro-fastener adhesive.

**Indications:**

- Osgood-Schlatter disease.

**Colour:** ■ Orange.



**Exhibitor**

Ref.: EXP-SP110

Units: 10

Sizes: 13 x 22 x 17 cm





▶ 3-Tex® Video

A NEW **CONCEPT** IN  
FUNCTIONAL ORTHOSES



**SILICONE BUBBLE GRIP**  
Prevents slippage and provides greater grip.



**PROXIMAL FINGER LOOPS**  
Make it easier to slide the knee support on



**SILICONE PATELLA PAD**  
Intermittent micromassage effect as the knee moves to promote the reabsorption of oedemas and haematomas.

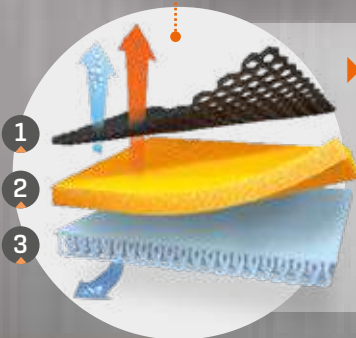

▶ **THREE-LAYER BREATHABLE MATERIAL**

New material composed of 3 layers that fit perfectly to form a "second skin".

- 1-Elastic membrane.
- 2-Thinner foam.
- 3-Elastic terry cloth.



→ **CLINICAL EFFECTIVENESS**

+ **COMFORT OF USE**



MAIN FEATURES

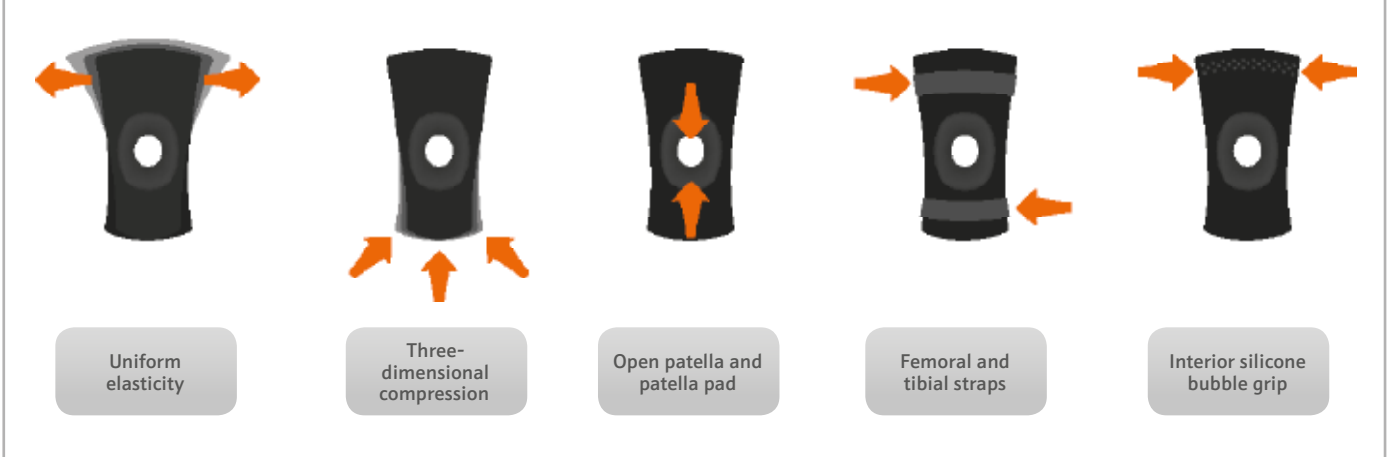

Uniform elasticity

Three-dimensional compression

Open patella and patella pad

Femoral and tibial straps

Interior silicone bubble grip

LOWER LIMBS



Ref.: 6103 BEIGE | Ref.: 7103 BLACK

F ... C ... S .. I ..

**KNEE BRACE WITH FLEXIBLE LATERAL REINFORCEMENTS**

SIZES	PERIMETER CM	
1	32-34	<p>Perimeter in cm around centre of kneecap</p>
2	34-36	
3	36-38	<p>HEIGHT 32 cm</p> <p>POSSIBILITY TO CUSTOMISE</p>
4	38-41	
5	41-44	
6	44-49	

**Characteristics:**

Fabric knee support made from three-layer breathable elastic material. Composed of three layers – elastic microfibre fabric, polyurethane foam and terry cloth – which facilitates rapid dispersion of sweat, greater elasticity and a better fit. Features silicone bubble grip to prevent slippage, open patella with patella pad, side stabilisers and femoral and tibial straps for firmer fastening.

**Effects:**

Support and stability. Light compression in the quadriceps and patellar tendons.

**Indications:**

- Joint pain.
- Osteoarthritis and arthritis.
- Tendinitis.
- Mild patellar and mediolateral instability.
- Post-surgical treatments.

**Colours:**

6103: Beige.  
7103: Black.



Ref.: 6119 BEIGE | Ref.: 7119 BLACK

F ... C ... S .. I ..

**WRAP-AROUND KNEE SUPPORT WITH MEDIOLATERAL STRAPS**

SIZES	ONE SIZE	
		<p>HEIGHT 28 cm</p> <p>POSSIBILITY TO CUSTOMISE</p>



**Characteristics:**

Fabric knee support in three-layer breathable elastic material. Made from elastic velour (knee area) and elastic fabric (strap area). Composed of three layers – elastic microfibre fabric, polyurethane foam and terry cloth – which facilitates rapid dispersion of sweat, greater elasticity and a better fit, and features silicone bubble grip to prevent slippage. Open patella with patella pad, mediolateral straps and opening in the popliteal area.

**Effects:**

Compression, support and stability.

**Indications:**

- Stabilisation during sports activities or straining situations.
- Patients whose special morphology requires quick and easy placement.

**Colours:**

6119: Beige.  
7119: Black.



Ref.: 6104 BEIGE | Ref.: 7104 BLACK

F ... C ... S ... I ...

**KNEE BRACE WITH POLYCENTRIC JOINTS**

SIZES	PERIMETER CM	
1	32-34	<p>Perimeter in cm around centre of kneecap</p>
2	34-36	
3	36-38	
4	38-41	<p>HEIGHT 35 cm</p>
5	41-44	
6	44-49	

**Characteristics:**

Fabric knee support made from three-layer breathable elastic material. Composed of three layers – elastic microfibre fabric, polyurethane foam and terry cloth – which facilitates rapid dispersion of sweat, greater elasticity and a better fit. Features silicone bubble grip to prevent slippage. Open patella with silicone patella pad, metal straps with polycentric joints, femoral and tibial straps for firmer fastening and calf opening.

**Effects:**

Support and stability. The polycentric joints provide enhanced stability at mediolateral level. Light compression in the quadriceps and patellar tendons. With the movement of the knee, the silicone pad produces an intermittent micromassage effect to promote the reabsorption of oedemas and haematomas.

**Indications:**

- Joint pain.
- Osteoarthritis and arthritis.
- Tendinitis.
- Mild mediolateral instability.
- Capsular ligament injuries.

**Colours:**

- 6104: Beige.
- 7104: Black.



Ref.: 6104-A BEIGE | Ref.: 7104-A BLACK

F ... C ... S ... I ...

**OPEN KNEE SUPPORT WITH POLYCENTRIC JOINTS**

SIZES	PERIMETER CM	
1	32-34	<p>Perimeter in cm around centre of kneecap</p>
2	34-36	
3	36-38	
4	38-41	<p>HEIGHT 35 cm</p>
5	41-44	
6	44-49	

**Characteristics:**

Fabric knee support made from three-layer breathable elastic material. Composed of three layers – elastic microfibre fabric, polyurethane foam and terry cloth – which facilitates rapid dispersion of sweat, greater elasticity and a better fit. Features silicone bubble grip to prevent slippage. Open patella, metal straps with polycentric joints, femoral and tibial straps for firmer fastening.

**Effects:**

Support and stability. The polycentric joints provide enhanced stability at mediolateral level.

**Indications:**

- Joint pain.
- Osteoarthritis and arthritis.
- Tendinitis.
- Mild mediolateral instability.

**Colours:**

- 6104-A: Beige.
- 7104-A: Black.



Ref.: 6120 BEIGE | Ref.: 7120 BLACK

F ... C ... S ... I ...

**WRAP-AROUND KNEE SUPPORT WITH POLYCENTRIC JOINTS**

SIZES	PERIMETER CM	
1	32-36	<p>Perimeter in cm around centre of kneecap</p>
2	36-41	
3	41-49	<p>HEIGHT 35 cm</p>

**Characteristics:**

Fabric knee support in three-layer breathable elastic material. Made from elastic velour (knee area) and elastic fabric (strap area); composed of three layers – elastic microfibre fabric, polyurethane foam and terry cloth – which facilitates rapid dispersion of sweat, greater elasticity and a better fit, and features silicone bubble grip to prevent slippage. Open patella with patella pad, polycentric joints with mediolateral straps, opening in the popliteal area and wrap-around closure system.

**Effects:**

Compression, support and mediolateral stabilisation.

**Indications:**

- Joint pain.
- Mild mediolateral instability.
- Capsular ligament injuries.
- Post-surgical knee treatments.
- Stabilisation during sports activities or straining situations.
- Patients whose special morphology requires quick and easy placement.

**Colours:**

- 6120: Beige.
- 7120: Black.







Ref.: 6112 BEIGE | Ref.: 7112 BLACK

F ... C ... S ... I ...

SHORT FLEXION-EXTENSION KNEE SUPPORT

SIZES	PERIMETER CM	
1	32-34	
2	34-36	
3	36-38	Perimeter in cm around centre of kneecap
4	38-41	
5	41-44	
6	44-49	HEIGHT 35 cm POSSIBILITY TO CUT 30mm

**Characteristics:**

Fabric knee support made from three-layer breathable elastic material. Composed of three layers – elastic microfibre fabric, polyurethane foam and terry cloth – which facilitates rapid dispersion of sweat, greater elasticity and a better fit. Features silicone bubble grip to prevent slippage. Polycentric joint with 0-15-30-60-90° in flexion-extension, patella pad below the knee. Femoral and tibial straps for a better fit.

**Effects:**

Compression, support and mediolateral stabilisation. Flexion-extension movement range control.

**Indications:**

- Post-surgical knee treatment.
- Post-injury rehabilitation.
- Disorders in which the movement range of the knee joint needs to be controlled.

**Colours:**

6112: Beige.  
7112: Black.



Ref.: 6113 BEIGE | Ref.: 7113 BLACK

F ... C ... S ... I ...

LONG/OPEN FLEXION-EXTENSION KNEE SUPPORT

SIZES	PERIMETER CM	
1	32-34	
2	34-36	
3	36-38	Perimeter in cm around centre of kneecap
4	38-41	
5	41-44	
6	44-49	HEIGHT 45 cm POSSIBILITY TO CUT 30mm

**Characteristics:**

Fabric knee support made from three-layer breathable elastic material. Composed of three layers – elastic microfibre fabric, polyurethane foam and terry cloth – which facilitates rapid dispersion of sweat, greater elasticity and a better fit. Features silicone bubble grip to prevent slippage. Polycentric joint with 0-15-30-60-90° in flexion-extension. Femoral and tibial straps for a better fit.

**Effects:**

Compression, support and mediolateral stabilisation. Flexion-extension movement range control.

**Indications:**

- Post-surgical knee treatment.
- Post-injury rehabilitation.
- Disorders in which the movement range of the knee joint needs to be controlled.

**Colours:**

6113: Beige.  
7113: Black.



Ref.: 7117D RIGHT | Ref.: 7117I LEFT

F ... C ... S ... I ...

KNEE SUPPORT FOR LATERAL OR MEDIAL PATELLA CONTROL

SIZES	PERIMETER CM	
1	32-34	
2	34-36	
3	36-38	Perimeter in cm around centre of kneecap
4	38-41	
5	41-44	
6	44-49	HEIGHT 35 cm POSSIBILITY TO CUT 30mm

**Characteristics:**

Fabric knee support made from three-layer breathable elastic material. Composed of three layers – elastic microfibre fabric, polyurethane foam and terry cloth – which facilitates rapid dispersion of sweat, greater elasticity and a better fit. Features silicone bubble grip to prevent slippage. Features flexible mediolateral stabilisers, semi-circular silicone patella cushion and patella pad, also semi-circular.

**Effects:**

Compression, support and mediolateral and flexion-extension stabilisation.

**Indications:**

- External or internal hyperpressure syndromes and patellar subluxations.
- Prevention of recurring injuries (e.g. patellar luxation).
- Post-surgical treatment of the lateral or medial section of the retinaculum.

**Colour:** Black.

Pad position	Select ref.
Right outer	7117D (Right)
Right inner	7117I (Left)
Left outer	7117I (Left)
Left inner	7117D (Right)



**Genu Valgus**

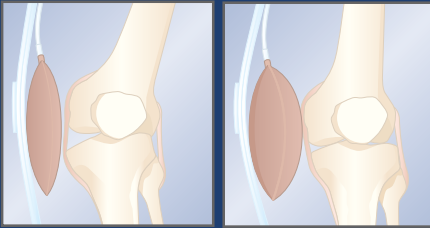

1 2

**Genu Varus**

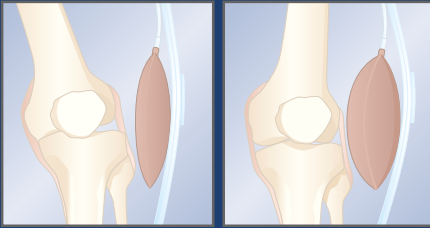

1 2

Important:  
Model for choosing the right as the pathology look at this table.

Pathology:	Reference to selection:
Genu Varus Knee Support Right	6121 D (Right)
Genu Valgus Knee Support Right	6121 I (Left)
Genu Varus Knee Support Left	6121 I (Left)
Genu Valgus Knee Support Left	6121 D (Right)



LOWER LIMBS



Ref.: 6121D RIGHT | Ref.: 6121I LEFT

F ... C ... S ... I ...

**VARUS-VALGUS KNEE SUPPORT**

SIZES	PERIMETER CM	
1	32-34	<p>Perimeter in cm around centre of kneecap</p>
2	34-36	
3	36-38	<p>HEIGHT 39 cm</p> <p>POSSIBILITY TO CUT</p>
4	38-41	
5	41-44	
6	44-49	

**Characteristics:**

Fabric knee support made from three-layer breathable elastic material. Composed of three layers – elastic microfibre fabric, polyurethane foam and terry cloth – which facilitates rapid dispersion of sweat, greater elasticity and a better fit. Features silicone bubble grip to prevent slippage.

Consisting of a patella pad, polycentric joint on one side with condyle air bag and inflation system, on the opposite side, it features flexible stays and 2 straps countering the inflatable bag, creating, by pressure of the three points, an opening or elongation of the obstructed compartment. Femoral and tibial straps for firmer fastening with anterior femoral opening and posterior calf opening for ease of fitting.

**Indications:**

- Osteoarthritis of the medial or lateral compartments of the knee.
- Genu valgum or varum associated with osteoarthritis.
- Injuries to the medial or lateral meniscus.

**Colour:** Beige.



Internal or external condyle pressure to realign the femur with the tibia and enable correction of valgus or varus axial deviation while reducing the load on the affected compartment (medial or lateral) in the case of osteoarthritis. Increased compression caused by inflation of the bag, which produces load relief in the contralateral compartment and minimises pressure on the tibial plateau. The polycentric joint and inflation bag help to improve alignment.



Ref.: OCR300D RIGHT    Ref.: OCR300I LEFT

F    C    S    I

## FUNCTIONAL KNEE BRACE WITH UNILATERAL JOINT AND F/E AND VALGUS/VARUS ADJUSTMENT

SIZES

ONE SIZE

### Characteristics:

Lightweight and ergonomically designed, it contours to the morphology of the limb and adapts to anatomical shape changes during activities. The rigid structures for the thigh and calf are connected by a joint that allows flexion and extension control. The profile of the rigid parts is made from lower density plastic to improve comfort of use. The joint is supplied with a pre-installed stop which locks extension at 0° (preventing hyperextension) and a screwdriver that enables the stops to be changed for flexion/extension control. The foam fabric protections are breathable and can be easily removed for washing. The connection between the joint and the thigh piece features a hinge that enables varus or valgus axial adjustment to improve knee load distribution efficiency. It features a rapid, secure and easy to handle closure system that enables comfortable and efficient fitting and removal of the brace.

### Effects:

- Internal or external condyle pressure to realign thigh/leg axial deviation.
- Medial or lateral mechanical unloading of the knee.
- Stabilisation and restriction of joint range of motion.
- Pain relief.

### Indications:

- Mild or moderate unicompartmental knee osteoarthritis (medial or lateral).
- Genu valgum or varum associated with osteoarthritis.
- Medial or lateral meniscus injury.

### Colour: ■ Black.

### Limitation range:

- Extension: 0°, 10°, 20°, 30°, 40°
- Flexion: 0°, 10°, 20°, 30°, 45°, 60°, 75°, 90°

LEG	PATHOLOGY	REFERENCE
RIGHT	Varus	OCR300D
	Valgus	OCR300I
LEFT	Varus	OCR300I
	Valgus	OCR300D



+



=



Knee with osteoarthritis

Knee with Gonartec® Plus orthosis

The orthosis exerts a condylar pressure, realigning the axial deviation thigh / leg



Ref.: OCR400D RIGHT

Ref.: OCR400I LEFT

F ... C ... S ... I ...

FUNCTIONAL TEXTILE BRACE

SIZES	PERIMETER CM
1	32-35
2	35-38
3	38-42
4	42-47
5	47-52

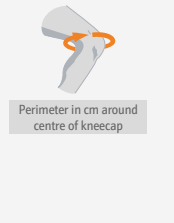

LEG	PATHOLOGY	REFERENCE
RIGHT	Varus	OCR400D
	Valgus	OCR400I
LEFT	Varus	OCR400I
	Valgus	OCR400D

**Characteristics:**

A comfortable and light orthosis for unicompartmental knee relief. With a wrap design, it adapts perfectly to the thigh and calf for easy adjustment and effective knee control. Features strong unilateral polycentric articulation for personalised varus/valgus regulation and possible flexion-extension limitation with wedges. For best results, 2 straps create a 3-point system to help relieve pain. These straps are colour-coded for easier closing. The textile material is soft, comfortable and breathable for knee joint compression. It features inner silicone elements to prevent the knee pad from moving as well as a pad in the areas of greatest pressure to prevent discomfort.

**Effects:**

- Inner or outer condylar pressure, realigning the axial thigh/leg deviation.
- Medial or lateral mechanical knee relief.
- Stabilises and restricts joint range of motion.
- Pain relief.

**Indications:**

- Minor or moderate unicompartmental osteoarthritis in the knee.
- Genu varus or genu valgus associated with arthrosis.
- Medial or lateral meniscus tear.

**Colour:** ■ Black.

**Limitation range:**

- Extension: 0°, 10°, 20°, 30°, 40°
- Flexion: 0°, 10, 20°, 30°, 45°, 60°, 75°, 90°





Ref.: 94230 SHORT 51cm  
Ref.: 94240 LONG 69cm

F ... C .. S .... I .....

## KNEE ORTHESIS WITH FLEXION-EXTENSION JOINT

SIZES	ONE SIZE	HEIGHT
		94230: 51 cm 94240: 69 cm



### Characteristics:

Knee orthosis that comprises two foam corsets, two Velcro straps and polycentric articulations adjustable at 0-15-30-60 and 90° to limit the flexion/extension.

### Indications:

- For unstable or injured knees.
- Post-operative and post-traumatic rehabilitation.
- For relative immobilisation of the articulation in situations that require perfect control.
- To obtain a range of control of the mobility of the operated knee (crossed ligament surgery).

### Colour:

■ Black.

### Models:

- 94230: Short.
- 94240: Long.



Ref.: IR-4000 40cm Ref.: IR-5000 50cm  
Ref.: IR-6000 60cm Ref.: IR-7000 70cm

F .... C ... S ..... I .....

## THREE PANELS KNEE IMMOBILIZER 0°

SIZES	ONE SIZE
Perimeter in cm around centre of knee-cap 32 a 55 cm	ALTEURA IR-4000: 40 cm IR-5000: 50 cm IR-6000: 60 cm IR-7000: 70 cm

### Characteristics:

Immobilising knee braces made of light, breathable material with terry-cloth lining. Rigid, conformable metal supports on the sides and back. The three-panel adjustment system can adapt to different morphologies. Strap closure on the inner panel for easy application and silicone strips on the inside.

### Indications:

- Pre- and post-surgical or post-trauma treatment.

### Colour:

■ Beige.



Ref.: IR-4100 40cm Ref.: IR-5100 50cm  
Ref.: IR-6100 60cm Ref.: IR-7100 70cm

F .... C ... S ..... I .....

## THREE PANELS KNEE IMMOBILIZER 0°

SIZES	ONE SIZE
Perimeter in cm around centre of knee-cap 32 a 55 cm	ALTEURA IR-4100: 40 cm IR-5100: 50 cm IR-6100: 60 cm IR-7100: 70 cm

### Characteristics:

Immobilising knee braces made of light, breathable material with terry-cloth lining. Rigid, conformable metal supports on the sides and back. The three-panel adjustment system can adapt to different morphologies. Strap closure on the inner panel for easy application and silicone strips on the inside.

### Indications:

- Pre- and post-surgical or post-trauma treatment.

### Colour:

■ Grey.





Ref.: IR-5001 (20°) / Ref.: IR-5002 (0°)

Ref.: IR-6001 (20°) / Ref.: IR-6002 (0°)

F ... C ... S ... I ...

## KNEE IMMOBILIZER 0°/20°

SIZES	PERIMETER CM
2	24-32
3	32-40
4	40-46
5	46-50



### Characteristics:

Knee immobiliser made with external nylon that repels humidity and facilitates cleaning, with internal cotton bouclé, anatomical rear plate, lateral plates at 0° flexion and padded condylar supports.

### Indications:

- Pre and post-surgical knee treatment where immobilisation is required with a certain degree of flexion.
- After injuries.

Colour: ■ Blue.



Ref.: 94231

S ... C ... E ... I ...

## OA KNEE BRACE

SIZES	PERIMETER CM
1	36-46
2	46-53
3	53-58

The circumference measurement is taken 15 cm above the center of the patella



### Characteristics:

Knee orthosis fitted with dual-axis polycentric joints, flexion-extension adjustment system and protective cover. Thigh and calf hemivalves in flexible thermoplastic with interior padding. Lined pads in the condylar area. The new design of the pins enables better fastening to the upper calf. The lower calf-level fastening strap is fitted with a silicone pad to increase the comfort and stability of the orthosis.

### Indications:

- Anteroposterior and medial collateral knee instability and injuries, cruciate ligament injuries.
- Post-surgical treatment of the knee.

Colour: ■ Black.





Ref.: 94250 (4 Narrow bands, 4 Straps)

S ... C ... E ... I ...

## KNEE BRACE WITH FLEXION AND EXTENSION STOPS

SIZES ONE SIZE



▶ 94250 Video

### Characteristics:

Knee brace with monocentric joint consisting of four trimmable foam and velour straps (two for the thigh and two for the calf). The mediolateral supports perform a fastening function and are height adjustable to ensure a comfortable fit.

Possibility of controlling the range of movement from full extension  $-10^\circ$  to  $120^\circ$  of flexion.

### Indications:

- Unstable or injured knees.
- Post-operative and post-injury rehabilitation.
- For relative immobilisation of the joint in situations requiring full control.
- When control of the range of movement of the post-operative knee is required (after surgery to repair the ACL, PCL, LCL and MCL ligaments, meniscus and patellar tendon).
- Mild genu recurvatum (hyperextension).

Colour: ■ Black.



#### Flexion-extension control

- Flexion: from  $0^\circ$  to  $120^\circ$  (at intervals of  $10^\circ$  to  $30^\circ$  and at intervals of  $15^\circ$  to  $120^\circ$ ).
- Extension: from  $0^\circ$  to  $90^\circ$  (at intervals of  $10^\circ$  to  $30^\circ$  and at intervals of  $15^\circ$  to  $90^\circ$ ).
- Total immobilisation of  $0^\circ$  to  $45^\circ$ .

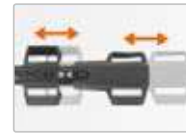

Telescopic aluminium rods and friction clips to adjust the height.



Adjustable closure system.



Ref.: 94260 (4 Narrow bands, 4 Straps)

F ... C ... S ... I ...

Ref.: 94261 (2 Wide bands, 4 Straps)

F ... C ... S ... I ...

## ADJUSTABLE KNEE ORTHOSIS WITH LOCK SYSTEM

SIZES ONE SIZE

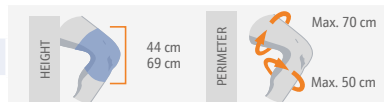

### Characteristics:

Knee orthosis with monocentric articulation.  $-10^\circ$  to  $+30^\circ$  locking system.  $-10^\circ$  to  $120^\circ$  flexion control in intervals of  $10^\circ$  and  $-10^\circ$  to  $+30^\circ$  extension control in intervals of  $10^\circ$ . Ref.: 94260 has 2 femoral straps (thigh) and 2 tibia straps (calf), Ref.: 94261 has 2 wide strips which cover practically all the knee.

### Indications:

- For unstable or lesioned knees.
- Post-operation and post-traumatic rehabilitation.
- For relative immobilisation of the articulation in situations which require perfect control.
- When we are interested in controlling the mobility of the post-operation knee (cruciate ligament surgery).

Colour: ■ Black/Grey.



The mediolateral foam padded plates prevent the orthosis from rubbing against the leg, and are fitted with a fastening system with straps for adjustment.

Prolongation system using telescopic bars and friction clips to set the bar at the required height, from a minimum of 44 cm up to a maximum of 69 cm.

Ref.: 94260



Ref.: 94261



▶  
**OCR**  
Video

Pivoted fastening for improved dynamic adjustment

Lightweight aluminium alloy, similar to that used in the aviation industry

Slip-resistant lining for improved stabilisation during movement

Interior slip-resistant protective pads

Knee articulation with flexion and extension adjustment system

Air-filled condyle pads

Adjustable fastening straps

WEDGES			
Flexion		Extension	
	90°		40°
	75°		30°
	60°		20°
	45°		10°
			0°
			PRE-FITTED



**I Fitting the stops**

Adjustment of flexion and extension.

The orthosis is supplied with a set of stops to adjust flexion and extension.

- Select the desired stops.
- Unscrew the protective cover to enable the selected stop to be inserted.
- Once fitted, tighten the screw to fasten the cover and the stop. Repeat this process to adjust both the flexion and extension directions.





Ref.: **OCR100D** RIGHT | Ref.: **OCR100I** LEFT

S ..... C .. E ..... I .....

**FUNCTIONAL KNEE ORTHOSIS WITH FLEXION-EXTENSION CONTROL- OCR100**

**Characteristics:**

Made from low profile lightweight aluminium, it features dynamic polycentric joints with flexion and extension control and limitation. Non-slip interior lining to provide comfort and protection. The joints include air-cushioned condyle pads. To adjust flexion and extension, it has galvanised steel wedges (to prevent corrosion) with different graduations. Limitation range:  
 Extension: 0°, 10°, 20°, 30°, 40°.  
 Flexion: 45°, 60°, 75°, 90°.  
 The aluminium allows small individual adjustment.  
 Adjustment and fastening system by means of adjustable straps that include non-slip protection pads for a better fit.

**Indications:**

Collateral ligament injuries (tears), conservative treatment of instability resulting from combined knee injuries, ruptured cruciate ligaments combined with collateral ligament injuries (triad) and postoperative treatment after ligament surgery (ACL) and (PCL).

**Colour:** ■ Black.



Ref.: **OCR200D** RIGHT | Ref.: **OCR200I** LEFT

S ..... C .. E ..... I .....

**FUNCTIONAL KNEE ORTHOSIS WITH FLEXION-EXTENSION CONTROL- OCR200**

SIZES	PERIMETER CM
1	34-41
2	41-48
3	48-55
4	55-62
5	62-69

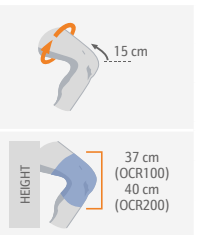

**Functions:**

- Control of knee joint mobility.
- Mediolateral and valgus-varus stabilisation.
- Limitation of anteroposterior tibial slip (drawer effect).
- Control of hyper-extension and medial rotation.

**MAIN FEATURES - OCR® Major Goals**

- Control of tibial translation
- Stabilize from anteroposterior forces
- Reduce strain on ligaments
- Control of mediolateral and rotational instability

FORCE	DESCRIPTION	EFFECT
F <sub>A1</sub>	Anterior Thigh Cuff (+ strap)	Anchors the femur
F <sub>A2</sub>	Posterior Distal Thigh Strap	Pushes the femur anteriorly
F <sub>A3</sub>	Posterior Proximal Tibia Strap	Produces an anterior-directed force and restrain posterior displacement of the tibia relative to the femur. By tightening and affixing this strap, the hinge is drawn into proper position, and the tibia is rotated anteriorly.
F <sub>A4</sub>	Anterior Calf Cuff	Anchors the tibia

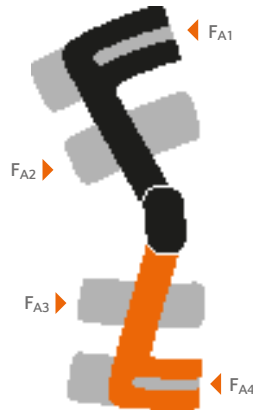

The PCL restrains posterior displacement of the tibia in its articulation with the femur, especially as the knee moves toward full extension. The OCR100 can be more effective on protecting the PCL by controlling the excessive posterior drawer movement of the tibia.

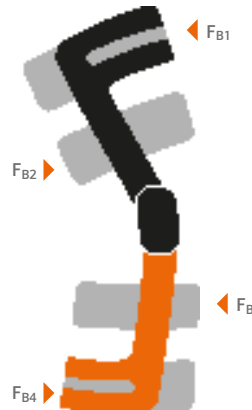

FORCE	DESCRIPTION	EFFECT
F <sub>B1</sub>	Anterior Thigh Cuff (+ strap)	Anchors the femur
F <sub>B2</sub>	Posterior Distal Thigh Strap	Pushes the femur anteriorly
F <sub>B3</sub>	Anterior Proximal Tibia Strap	Applies constant posterior load to prevent anterior tibial translation. By tightening and affixing this strap, the hinge is drawn into proper position, and the tibia is rotated posteriorly.
F <sub>B4</sub>	Posterior Calf Cuff	Anchors the tibia

The ACL prevents forward shift and excessive medial rotation of the tibia as the knee moves toward extension. The OCR200 can be more effective on protecting the ACL by controlling the excessive anterior drawer movement of the tibia.

The sensory system of the knee ligaments is able to contribute significantly to the functional stability of the knee joint. When there is an ACL injury, the tibia naturally moves anteriorly and subluxes just before the foot hits the ground, in the terminal swing phase of the gait. When the PCL is injured the tibia naturally moves posteriorly, as the knee moves further into flexion. The OCR braces apply counterforces to the knee complex in order to keep the tibia in proper alignment restoring joint stability.

ACCESSORIES



**Ref.: OCR204**

**AIR-CUSHIONED**

Air-cushioned condyle pad for better protection with inflation system to regulate the compression level.

**SIZES** ONE SIZE



**Ref.: OCR202**

**PADDING KIT**

- Units: 2.
- Colour: ■ Black.

**SIZES** ONE SIZE



**Ref.: OCR203**

**STRAPS KIT + NON SKID PADS**

- Includes: 6 Straps, 6 pads and 12 fastening hooks.

STRAP NUMBER	SIZES LENGTH CM				
	1	2	3	4	5
2	40	40	40	50	50
3	40	40	40	50	50
6	40	40	40	50	50
4	30	30	30	40	40
5	30	30	30	40	40
1	30	30	30	40	40

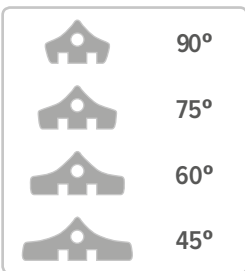

**Ref.: OCR205F**

**FLEXION STOP KIT**

Includes bag with all flexion stops.

**SIZES** ONE SIZE

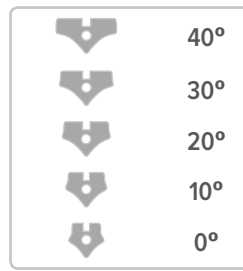

**Ref.: OCR205E**

**EXTENSION STOP KIT**

Includes bag with all extension stops.

**SIZES** ONE SIZE



**Ref.: OCR101D | Ref.: OCR101I**

**COMPLETE LINING KIT RIGHT / LEFT**

- It contains an upper and lower lining.
- Colour: ■ Black.

**SIZES** 1 2 3 4 5

Correspond to the sizes of models OCR100D / OCR100I



**Ref.: OCR201D | Ref.: OCR201I**

**COMPLETE LINING KIT RIGHT / LEFT**

- It contains an upper and lower lining.
- Colour: ■ Black.

**SIZES** 1 2 3 4 5

Correspond to the sizes of models OCR200D / OCR200I

# Thigh support / Calf support



Ref.: TP-4500



Ref.: TP-4500C



Ref.: TP-4500 | Ref.: TP-4500C SHORT



## FABRIC THIGH SUPPORT WITH THERMOPLASTIC PLATES

SIZES	PERIMETER CM	HEIGHT CM	
1	41-44	TP-4500	29
2	44-48	TP-4500C	24
3	48-53	PERIMETER IN CM OF THIGH	HEIGHT
4	53-58		
5	58-63		

### Characteristics:

Made from velour with a breathable Lycra lining, it features inner breathable honeycomb fabric pockets into which 2 mm-thick, low-density polyethylene thermoplastic plates are inserted (at the front and rear). Upper and lower velour straps for fastening with adjuster buckles and Velcro closure.

Two models available depending on the height of the patient.

### Indications:

- As a method of protection for patients undertaking work or sport-related activities while carrying certain injuries, such as 1st or 2nd degree fibrillar damage, minor tears and muscle strain.

**Colour:**  Grey.

Ref.: TP-4800



Ref.: TP-4801



Ref.: TP-4800 | Ref.: TP-4801  
Tibia guard accessory



## CALF SUPPORT WITH THERMOPLASTIC PLATES

### Ref.: TP-4800

SIZES	PERIMETER CM	PERIMETER IN CM OF CALF	HEIGHT
1	25-27		
2	27-30		
3	30-33		
4	33-37		
5	37-41		

### Characteristics:

Made from velour with a breathable Lycra lining, it features a breathable honeycomb fabric pocket at the rear into which a 2 mm-thick, low-density polyethylene thermoplastic plate is inserted. Zip opening system.

Tibia guard accessory Ref: TP-4801. The calf support can be fitted with a tibia guard accessory made from velour with inner honeycomb fabric into which a 2 mm-thick, low-density polyethylene thermoplastic plate is inserted and Velcro fastened. Upper and lower straps for fastening and adjustment.

### Indications:

- As a method of protection for patients undertaking work or sport-related activities while carrying certain injuries, such as 1st or 2nd degree fibrillar damage, minor tears and muscle strain.

**Colour:**  Grey.

### Ref.: TP-4801

SIZES	ONE SIZE



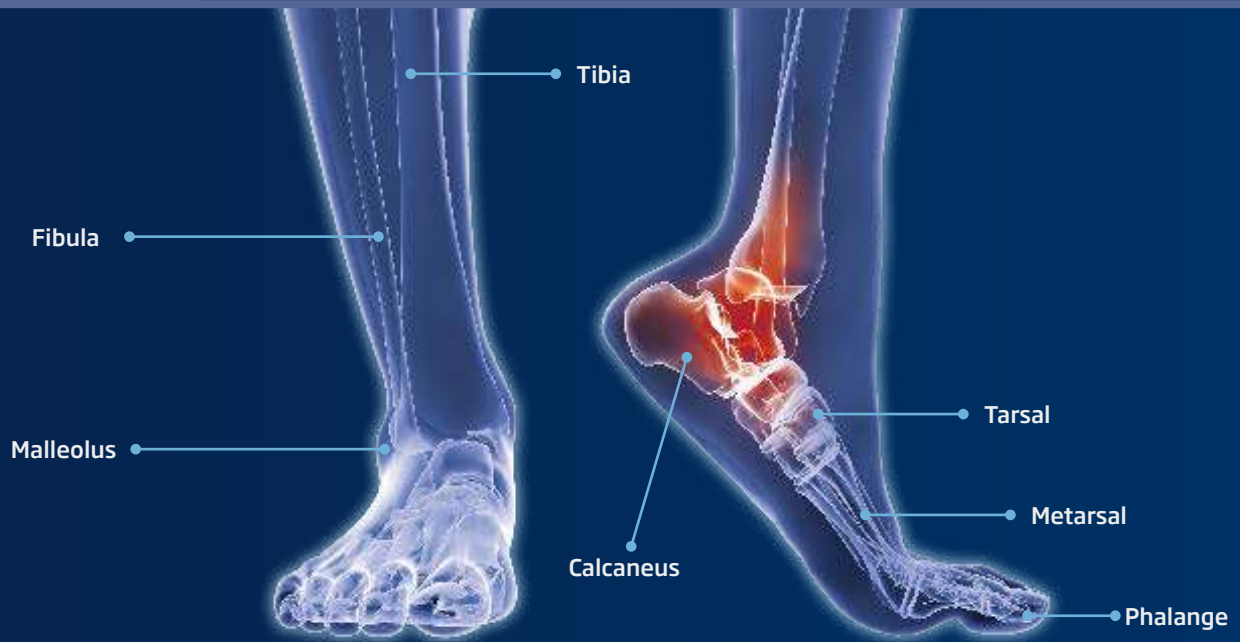

**F** Fastening   **C** Compression   **S** Stabilisation   **I** Immobilization

## Ankle Orthoses



Ref.: TOB-500B   Ref.: TOB-500N  
BEIGE   BLACK

**F** ..   **C** ...   **S** ..   **I** ..

### CROSSOVER ELASTIC ANKLE SUPPORT

SIZES	PERIMETER CM
1	<19
2	19-20
3	20-23
4	23-25
5	>25



**Characteristics:**

Sock-type ankle support of soft and highly resistant elastic material and figure-of-eight elastic band.

**Indications:**

- Minor injuries.
- Luxations.
- As a precaution during sports activities.

**Colours:**

TOB-500B: ■ Beige.  
TOB-500N: ■ Black.



Ref.: EST-084

**F** ...   **C** ..   **S** ...   **I** ...

### BREATHABLE ANKLE SUPPORT WITH THERMOPLASTIC PLATES



SIZES	PERIMETER CM
1	<19
2	19-20
3	20-23
4	23-25



**Characteristics:**

Ankle stabiliser made in breathable semi-rigid fabric and designed to be able to opt for different indications, depending on the chosen configuration, as we can select from three types of components: conventional ankle support, ankle support with pronosupine webbing and ankle support with webbing and malleolar plates (internally and externally identified).

**Indications:**

- Conservative treatment in breakage of ankle ligaments.
- As postoperative protection in reconstructive ligament interventions.
- Injury of medial and lateral ankle ligaments.
- Chronic ankle instability.
- Post-operative rehabilitation. Tendinopathies.

**Colour:** ■ Blue.

# Tobisil® ▶ Ankle Orthosis



Ref.: 8401 BEIGE Ref.: 9401 BLACK

F .. C ... S .. I ..

## ELASTIC ANKLE SUPPORT WITH VISCOLASTIC PADS

SIZES	PERIMETER CM
1	17-19
2	19-21
3	21-23
4	23-25
5	25-27
6	27-29



### Characteristics:

Developed in breathable elastic knitted fabric using flat weaving, it incorporates two anatomically shaped Viscolastic pads which redistribute the compression of the bandage from the protruding malleoli towards the fleshy parts around them.

### Indications:

- Post-operative and post-traumatic irritation (e.g. after sprains).
- joint effusions and inflammations in the case of osteoarthritis and arthritis, tendinopathies, weak ligaments, prevention of sports or work-related injuries.

### Colours:

- 8401: ■ Beige.
- 9401: ■ Black.



Reabsorption of oedemas, effusions, haematomas due to the compression effect of its fabric (pressotherapy). The pads distribute the compression towards the fleshy parts around the malleoli. The compression exerted by the elastic fabric and silicone pads provides support and stabilisation to the ankle joint.

# Tobiplus® ▶ Ankle Orthosis

Redesign

Sin  
LATEX  
free



With a design inspired by the anatomy of the ankle and a combination of state-of-the-art materials, the new Tobiplus® provides the proper functional stability for the recovery of ankle injuries.



Ref.: EST-090

F ... C .. S ... I ...

## ANKLE STABILISER FEATURING TRY-TECH TECHNOLOGY

SIZES	PERIMETER CM
1	17-20
2	20-24,5
3	24,9-29



BREATHABLE

ABSORBENT

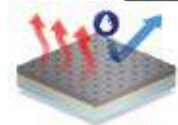

### Characteristics:

Figure-8 stabiliser system with semi-elastic straps Used with semi-rigid side reinforcements, it gives the ankle immense stability. Made with 3D Poromax® fabric for high breathability, resistance and protection. Non-slip material in the heel to ensure proper position while exercising. Quick and easy lace-up with a pull strap on the back for easier fitting. Designed anatomically with thin materials to be used with any type of footwear.

### Indications:

- Sprains (grade II or I) and contusions.
- Joint instability.
- Postoperative or post-traumatic recovery.

### Colour: ■ Black.



## MAIN FEATURES

Breathable flat-knit elastic fabric with anatomical design.



Silicone pad that encapsulates and relieves strain on the Achilles tendon.

The knit on the ends provides a less pronounced degree of pressure to prevent constriction.



The pad design contains high-relief points that, together with the compressive effect of the fabric, massage the soft tissue, promoting muscle activation and enhancing sensory feedback processes.



Ref.: 9402 AMBIDEXTROUS

S .. C ... E .. I ..

### ELASTIC ANKLE BRACE WITH ACHILLES TENDON PAD AND HEEL CUSHION

SIZES	PERIMETER CM
1	17-19
2	19-21
3	21-23
4	23-25
5	25-27
6	27-29

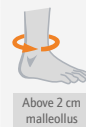

Above 2 cm malleolus

#### Pad:

The pad design contains high-relief points that, together with the compressive effect of the fabric, massage the soft tissue, promoting muscle activation and enhancing sensory feedback processes.

The pad is covered with towelling to maintain the comfort and breathability of all of the product and prevent the build up of moisture. It is supplied with silicone heel cushions for improved Achilles tendon strain relief.



#### Characteristics:

Made from breathable flat-knit elastic fabric with anatomical design. The knit on the ends provides a less pronounced degree of pressure to prevent constriction. The lower part, which supports the heel, is low profile for comfortable and imperceptible use. It features a pad that encapsulates and relieves strain on the Achilles tendon, guiding it when the ankle moves during activities such as walking and sport.

#### Effects:

- Prevents Achilles tendon overload.
- Reduces inflammation and haematoma.
- Improves muscle tone and proprioception.
- Protects during physical activity.
- Relieves pain and irritation.

With use of the heel cushion (slight increase in plantar flexion):

- Improved relief of Achilles tendon strain.
- Decreased mechanical shock received by the ankle, knee, hip and trunk joints during activity.

#### Indications:

Prevention and treatment of conditions that affect the Achilles tendon:

- Tendinitis.
- Haglund's syndrome.
- Retrocalcaneal bursitis.
- Chronic painful conditions due to wear.
- Post-operative achillodynia.

Colour: ■ Black.

MAIN FEATURES



It features anatomically designed medio-lateral stabilisers with an anti-rotational angle, providing excellent control of the eversion-inversion movements of the ankle and foot.



The rear strap enables individualised fitting and prevents both plates from slipping at moments of extreme biomechanical loads.



The varus correction strap provides rearfoot pronation, avoiding supination movements, which are the main cause of sprains and other sports-related injuries, and allowing the user to regulate the desired traction strength to obtain the necessary stabilisation level.



Ref.: EST-091D  
RIGHT

Ref.: EST-091I  
LEFT

F ... C .. S ... I ...

ANKLE BRACE WITH MEDIOLATERAL STABILISING SPLINT

SIZES	PERIMETER CM
1	17-20
2	20-25
3	25-30



▶ Altex® Video

Characteristics:

Manufactured in breathable velour and featuring mediolateral stabilisers at an anti-rotational angle to provide excellent protection. Its design and the materials with which it is manufactured allows it to be adapted to all types of footwear, providing comfort and safety at the same time. Its system of stabilising straps enables a personalised fit:

The rear strap enables individualised fitting and prevents both plates from slipping at moments of greater mechanical load. The varus correction strap provides the control required to prevent the supination movements that can cause sprains and other sports-related ankle injuries.

Indications:

Chronic ligament insufficiency (recurrent sprains), as a method of preventing sports-related injuries, in post-surgical rehabilitation and in grade 1 or 2 sprains.

Colour: ■ Black.

LOWER LIMBS

Valfeet® AIR ▶ Air Inflatable Ankle Stabilising Orthosis



Ref.: 2SSD RIGHT

Ref.: 2SSI LEFT

Ref.: 1SSD RIGHT

Ref.: 1SSI LEFT

"VALFEET AIR" INFLATABLE ANKLE STABILISING ORTHOSIS

"VALFEET XR" ANKLE STABILISING ORTHOSIS WITHOUT THE AIR CHAMBERS

F ... C .... S ..... I ...

SIZES	FOOTWEAR SIZE
1	35-37
2	38-40
3	41-43
4	44-46

Characteristics:

Stabilising orthosis to control the ankle, made up of two thermoplastic malleolar valves that are articulated with the sole support and inflatable malleolar linings for greater individualisation and stability. Includes 2 pads in the back of each strap area to prevent rubbing.

Indications:

- Post-injury immobilisation.
- Functional recovery. Instabilities.
- Prevention of sports injuries.
- Plantar fasciitis.

Colour: ■ Black.



Ref.: CINCHA-VAL

Both Valfeet models incorporate the possibility of adapting a strap kit for treatments such as equinovarus foot, plantar fasciitis, etc.





Ref.: EST-085

F ... C .. S ... I ...

ANKLE SUPPORT

SIZES	FOOTWEAR SIZE
1	<36
2	≥36

Characteristics:

Bivalve ankle foot orthosis, in rigid thermoplastic, provided with an interior foam cushion with memory. Includes a regulating system on the ankle and a Velcro closure system for the medio lateral stabilisation and immobilisation of the tibio tarsal joint. Includes 2 pads in the back of each strap area to prevent rubbing.

Indications:

• Ankle sprains, tendonitis, post-operative ligaments of the ankle, such as prophylaxis on static alterations of the foot, especially from sports activities. Specially recommended for deltoid sprains, as well as sprains on anterior talofibular ligament, both which require a much longer recovery time.

Colour:  Black.



Ref.: EST-082

F ... C .. S ... I ...

ANKLE ORTHOSIS WITH GEL

SIZES	ONE SIZE
-------	----------

Characteristics:

Bivalve ankle foot orthosis, in rigid thermoplastic, with inner memory-foam cushion and gel pads for cold therapy. The orthosis has been designed to allow use with the foam cushions alone or, if cold therapy is required, the gel pads can be inserted through the window in the foam cushion lining, which will adapt to accommodate them. The gel pads should be kept in the freezer for two hours beforehand. If the gel is used, we recommend removing the malleolar protection on the internal part of the valves. Includes 2 pads in the back of each strap area to prevent rubbing.

Indications:

• The indications of the EST-082 model are the same as those of the EST-085 when used without the gel pads. When these pads are used: Cold therapy, particularly during the practice of sports when an analgesic effect is required.

Colour:  Black.

## Plantar Fasciitis Orthosis



Ref.: FP01

ORTHOSIS FOR THE TREATMENT OF PLANTAR FASCIITIS

SIZES	PERIMETER CM
1	17-21
2	21-25
3	25-29



Characteristics:

An orthosis designed for the treatment of plantar fasciitis, composed of an anatomical velour band that closes over the top of the ankle with Velcro fasteners, to which an elastic strap is attached which passes under the ankle joint in order to apply pressure to the area between the calcaneal tuberosity and the plantar fascia. The anatomical velour band features gel pads that improve comfort and prevent chafing.

Indications:

• Plantar fasciitis.

Colour:  Grey.

Gel pads





# Leaf spring orthosis



Dismounted		Mounted	
Ref.: TP-2102D RIGHT	Ref.: TP-2102I LEFT	Ref.: TP-2102DM RIGHT	Ref.: TP-2102IM LEFT
LEAF SPRING ORTHOSIS		F	C S I

SIZES	FOOTWEAR SIZE	HEIGHT
1	35-37	29
2	37-39	32
3	39-41	34
4	41-44	39

### Characteristics:

The leaf spring orthosis is manufactured from injected high density polypropylene. Thanks to its design it allows elasticity at the Achilles heel level, permitting plantar flexion or dorsal flexion whilst walking, preventing the foot from falling, especially in the balancing stage, and maintaining the foot at 90°. The orthosis allows small adaptations and modifications, applying heat by way of a hot air pistol.

### Indications:

- In general, patients affected by dorsal flexion limitation of the foot. Hemiplegia through vascular-cerebral accidents (ictus), flaccid palsy sequelas.
- Retraction of the Achilles heel in infantile cerebral palsy.
- External popliteal sciatic nerve lesions.
- This orthosis is not for use in patents with varus or valgus deviations of the rear foot, and spastic palsy.

### Colours:

White.

### Ref.: KIT-TP2102

#### LEAF SPRING ORTHOSIS KIT

The individual orthosis assembly kit can be ordered with Ref.: KIT-TP 2102, for which there are two sizes:

- Small size (for sizes 1 and 2 of the Anti-equine).
- Large size (for sizes 3 and 4 of the Anti-equine).



## ACCESSORIES



### Ref.: PAD-TP2102

#### LEAF SPRING PAD

SIZES ONE SIZE

# Ankle Control Orthosis



### Ref.: TP-2100

#### MULTI-POSITIONAL FOOT-ANKLE SPLINT

SIZES	FOOTWEAR SIZE	LENGTH CM
1	<32	21x28,5
2	32-38	24x31
3	39-44	26x32,5
4	>44	29x33,5



### Characteristics:

High-density polyethylene splint with internal or external regulation from 0° to 15°. The splint incorporates a system that allows us to regulate plantar and dorsal flexion over a 60° range in 10° intervals. The internal lining is bouclé in washable breathable cotton. Its fastening system comprises Velcro webbing with protection pads. Can be adapted to both the left and right foot.

### Indications:

- Post-operative therapy of the knee, hip and foot, whenever rotation control of the lower member is necessary (neutral position, internal or external rotation).
- As a splint for the positional control of the lower extremity in patients bed-ridden for long periods of time (intensive care unit).
- As a system to prevent deformities in bedridden patients (prevention).
- Hemiplegia.
- Paralysis of lower member.
- Chronic pain of the plantar fascia (plantar fasciitis).

### Colour:

White.



### Ref.: TPA-2100.1

#### ACCESSORY ON MULTI-POSITION SPLINT FOR ACTIVE REHABILITATION

SIZES ONE SIZE

### Characteristics:

With the active rehabilitation guide, the splint allows us to make plantar flexion movements against a resistance and the dorsal flexion thanks to the elastic strap, where the resistance can be adjusted to a higher or lower tension.

### Colour:

Black.

MAIN FEATURES



New indentation in the Achilles heel area to improve comfort and prevent local pressure areas



Hook fastening system

INTERIOR GEL PADDING  
Increased comfort for the Achilles tendon area



Inclusion of two additional gel pads to improve comfort

Inclusion of holes to improve breathability

SEE HOW IT WORKS ON THE DEMONSTRATION VIDEO:  
[www.orliman.com](http://www.orliman.com)



▶  
Boxia®  
Video



Ref.: AB01

F ... C .. S ... I .

BOXIA A.F.O.-DROP FOOT

Characteristics:

The Boxia® device consists of 2 separate parts: a support above the ankles and a non-slip support section to put between the tongue and shoelaces via a central hook type attachment (must be worn with laced shoes). Both parts are linked by an elastic strap which is adjustable according to how much bending is required. The back of the strap has interior gel padding for comfort on the Achilles tendon, while the instep area is lined to prevent unwanted friction and ease compression.

Indications:

• Ankle dorsiflexion weakness or inability.

Benefits:

Discreet, comfortable and flexible. It occupies little space in the shoe and is easily adjusted.

Colours:

AB01: ■ Black.  
AB02: ■ Beige.

SIZES	PERIMETER CM
0	13-17
1	17-21
2	21-25
3	25-29



How it works:

The Boxia® drop-foot support raises the forefoot, allowing plantarflexion at the heel, when stepping off the foot. It prevents the risk of trips over everyday items, such as rugs, kerbs and irregular surfaces.



**Ref.: AB14**

**CALF SUPPORT FOR THE BOXIA DROP FOOT ANKLE BRACE**



**Characteristics:**

The Boxia drop foot ankle brace's supramalleolar support stores a large amount of energy, similar to a pivot (support point), to enable it to transfer the necessary forces to lift a paralysed foot. In cases in which a patient shows intolerance due to excessive force, the Boxia calf support is recommended. It helps to stabilise the orthosis and restrict forces and stresses by transferring them from the ankle to the calf.

**Indications:**

· Ankle dorsiflexion weakness or inability.

**Colours:**

AB14: ■ Black.

AB24: ■ Beige.

SIZES AB01	SIZES AB14
0	0
1 - 2	1
3	2

Equivalences for chose the correct size.

**Easy to fit getting better stabilitation**

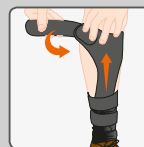
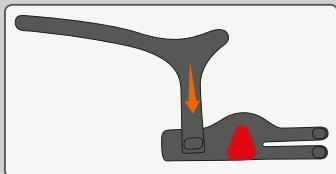

LOWER LIMBS



**Ref.: AB12D RIGHT**

**Ref.: AB12I LEFT**

**TO ADAPT TO AB01 (NOT INCLUDED)**

**INTERIOR ARCH SUPPORT**

SIZES	PERIMETER CM
1	17-21
2	21-25
3	25-29



**Characteristics:**

Anatomically designed to the shape of either the left or right foot, for supporting the arch area with padding. eference AB12 contains only the lower part for the foot. You must therefore already have part Ref: AB01 (Boxia dropfoot support).

**Colours:**

AB12D/ AB12I: ■ Black.

AB22D/ AB22I: ■ Beige.

**ACCESSORIES**



**Ref.: AB13**

**"S"-SHAPED HOOKS FOR BOXIA (2 UNITS)**

**SIZES** ONE SIZE



**Ref.: AB10**

**BOXIA TRACTION ELASTIC (1 UNIT)**

**SIZES** 1 2 3

Same sizes as for Ref: AB01.

**Colours:**

AB10: ■ Black.

AB20: ■ Beige.



**Ref.: AB11**

**BOXIA ATTACHMENT HOOK (2 UNITS)**

**SIZES** ONE SIZE

**Colours:**

AB11: ■ Black.

AB21: ■ Beige.

## MAIN FEATURES

**PADDED EDGING**  
Greater comfort

**INTERIOR GEL PADDING**  
Interior silicone pad with relief points

**Hook fastening system**

**One-handed closure system**

**ONE HAND & ON**

**ADJUSTABLE BUCKLE**  
Allows customized regulation of the perimeter

**Double hook fastening system**



Ref.: AB100

F ... C .. S ... I .

### BOXIA® FOOT SPLINT PLUS

SIZES	PERIMETER CM
1	14-20
2	20-26
3	26-32

#### Characteristics:

It can be fitted using just one hand which is an enormous advantage for patient autonomy and independence.

Comprised of:

- One supramalleolar part made of micro-perforated breathable fabric that wraps around the ankle. It features a pad in the back that hugs the Achilles tendon and provides maximum comfort and distributes pressure. There are also relief points offering a massage effect on the soft parts. The central anchoring system can be adjusted to the ankle perimeter to guarantee the most adequate position for each patient.
- An elastic traction band keeps the ankle in a neutral position and connects the supramalleolar part to the "S" hooks or the hook to the footwear.
- The anti-slip hook attached to the footwear and a strap that is secured to the laces prevents undesirable movement.
- 4 pairs of "S" hooks for greater stability and varum-valgum foot control.

#### Indications:

- Weakness or inability to dorsiflex the ankle (clubfoot) as a result of neurological injuries, congenital alterations or muscular disorders.
- Flaccid paralysis associated with hemiparesis.

**Colour:** ■ Black.

#### It comes with:

- 4 pairs of hooks Ref. AB13.
- 1 tongue with a hook for anchoring Ref. AB111.
- 1 elastic traction band Ref. AB110.



## ACCESSORIES



Ref.: AB111

TONGUE WITH A HOOK

SIZES ONE SIZE



Ref.: AB110

ELASTIC TRACTION BAND

SIZES 1 2 3



Ref.: AB13

2 UNITS

"S"-SHAPED HOOKS

SIZES ONE SIZE

Ref.: EST-088



Ref.: EST-087  
LONG

Ref.: EST-088  
SHORT

F ... C ... S ... I ...

## FIXED HIGH WALKER

### Ref.: EST-087

SIZES	FOOTWEAR SIZE	INCHES		HEIGHT
		FEMALE	MALE	
1	32-38	2-7	1-6	38
2	38-42	7-10	6-9	42
3	42-46	10-13	9-12	42

### Ref.: EST-088 SHORT

SIZES	FOOTWEAR SIZE	INCHES		HEIGHT
		FEMALE	MALE	
1	32-38	2-7	1-6	27
2	38-42	7-10	6-9	27
3	42-46	10-13	9-12	27

### Characteristics:

With a light and resistant design, it works from the proximal third of the leg to the foot with:

- Two metal side splints which can be adjusted for a perfect fit to the leg, connected to a low-profile non-slip rocker sole for easier walking;
- A back and front piece that extends to the back of the foot to reinforce immobilisation.
- A wrap-around pad made of breathable material for the leg, ankle and foot.
- Fixing straps for complete orthosis adaptation.
- Comes with protective pads and cushioned toe protection.

### Indications:

- Stable fractures in the lower third of the leg (distal fractures of the shinbone or fibula), ankle and foot.
- Achilles tendon and ligament injuries (Grade II and III sprains).
- Severe plantar fasciitis.
- Other post-surgical or post-trauma care.

### Colour: Black.



Ref.: EST-089

S ... C ... E ... I ...

## INFLATABLE FIXED HIGH WALKER

SIZES	FOOTWEAR SIZE	INCHES		HEIGHT
		FEMALE	MALE	
1	≤37	6,5	5	34,5
2	≤41	9,5	8	41,5
3	≤45	13	11,5	44,5

### Characteristics:

With a light and resistant design, it works from the proximal third of the leg to the foot with:

- One piece over the back and mediolateral area of the leg which extends along the sole of the foot.
- A low-profile non-slip rocker sole for easier walking featuring resistant and highly-durable shock absorption.
- One piece that extends to the back of the foot to reinforce immobilisation.
- A wrap-around pad made of breathable material for the leg, ankle and foot with an airbag (featuring an inflation pump and regulator valve) to optimize the contact surface with the limb for more effective immobilisation.
- Fixing straps for complete orthosis adaptation.
- Comes with protective pads and cushioned toe protection.

### Indications:

- Stable fractures in the lower third of the leg (distal fractures of the shinbone or fibula), ankle and foot.
- Achilles tendon and ligament injuries (Grade II and III sprains).
- Severe plantar fasciitis.
- To reduce oedema.
- Other post-surgical or post-trauma care.

### Colour: Grey.





Ref.: EST-092

S .... C ... E .... I .....

### INFLATABLE FIXED SHORT WALKER

SIZES	FOOTWEAR SIZE	INCHES		HEIGHT
		FEMALE	MALE	
1	≤37	6,5	5	21,7
2	≤41	9,5	8	25
3	≤45	13	11,5	26,5

#### Characteristics:

With a light and resistant design, it works from the middle third of the leg to the foot with:

- One piece over the back and mediolateral area of the leg which extends along the sole of the foot.
- A low-profile non-slip rocker sole for easier walking featuring resistant and highly-durable shock absorption.
- One piece that extends to the back of the foot to reinforce immobilisation.
- A wrap-around pad made of breathable material for the leg, ankle and foot with an airbag (featuring an inflation pump and regulator valve) to optimize the contact surface with the limb for more effective immobilisation.
- Fixing straps for complete orthosis adaptation.
- Comes with protective pads and cushioned toe protection.

#### Indications:

- Stable fractures of the lower third of the leg (distal fractures of the tibia or fibula), ankle and foot.
- Post-surgical treatment of Achilles tendon and ligament injuries (Grade II and III sprains).
- Severe plantar fasciitis.
- Oedema reduction.
- Other post-surgical care.

Colour:  Grey.



Ref.: EST-086

S .... C ... E .... I .....

### ARTICULATED HIGH WALKER

SIZES	FOOTWEAR SIZE	INCHES		HEIGHT
		FEMALE	MALE	
1	≤37	6,5	5	34,5
2	≤41	9,5	8	41,5
3	≤45	13	11,5	44,5

#### Characteristics:

With a light and resistant design, it works from the proximal third of the leg to the foot with:

- Two metal side splints which can be adjusted for a perfect fit to the leg, connected to a low-profile non-slip rocker sole for easier walking.
- Two monocentric joints with 0° to 45° flexion and extension adjustment at intervals of 7.5°.
- A back and front piece to reinforce immobilisation.
- A wrap-around pad made of breathable material for the leg, ankle and foot.
- Fixing straps for complete orthosis adaptation.
- Comes with protective pads and cushioned toe protection.

#### Indications:

- Stable fractures in the lower third of the leg (distal fractures of the shinbone or fibula), ankle and foot.
- Achilles tendon and ligament injuries (Grade II and III sprains).
- Severe plantar fasciitis.
- Other post-surgical or post-trauma care.

Colour:  Grey.



Ref.: EST-083

S C E I

### ARTICULATED HIGH AIR WALKER

SIZES	FOOTWEAR SIZE	INCHES		HEIGHT
		FEMALE	MALE	
1	≤37	6,5	5	36,5
2	≤41	9,5	8	40,5
3	≤45	13	11,5	40,5

**Characteristics:**

- With a light and resistant design, it works from the proximal third of the leg to the foot with:
  - Two metal side splints which can be adjusted for a perfect fit to the leg, connected to a low-profile non-slip rocker sole for easier walking;
  - Two monocentric joints with 0° to 45° flexion and extension adjustment at intervals of 7.5°.
  - A back and front piece to reinforce immobilisation.
  - A wrap-around pad made of breathable material for the leg, ankle and foot with an airbag (featuring an inflation pump and regulator valve) to optimize the contact surface with the limb for more effective immobilisation;
  - Fixing straps for complete orthosis adaptation.
- Comes with protective pads and cushioned toe protection.

**Indications:**

- Stable fractures in the lower third of the leg (distal fractures of the shinbone or fibula), ankle and foot.
- Achilles tendon and ligament injuries (Grade II and III sprains).
- Severe plantar fasciitis.
- To reduce oedema.
- Other post-surgical or post-trauma care.

**Colour:**  Grey.



Inflating pump



Flexion-extension control system



Ref.: AW01

### WEDGES FOR WALKERS (WEDGE FOR ACHILLES TENDON)

**Characteristics:**

During treatment with a Walker (ankle orthosis), and if the patient requires Achilles tendon repair, it is necessary to adjust the brace so that the foot is approximately at 20° of plantar flexion. As plantar reduction is progressive, a set of ergonomically-designed wedges are needed to reduce plantar flexion from 22° to 0° at intervals of 22°, 16°, 10° and 0°. To facilitate this, Orliman has designed a set of three 2-cm wedges and a heel cup that are joined together by removable adhesive, enabling easy assembly and separation.

**Colour:**  White-  Blue.

**Units:** 1.

WEDGE SIZE	EST-083 / EST-086			EST-087 / EST-088			EST-089		
	1	2	3	1	2	3	1	2	3
1				•			•		
2	•	•			•			•	
2			•			•			•

Equivalence chart for selecting the wedge size that best fits each walker.

TECHNICAL CHARACTERISTICS

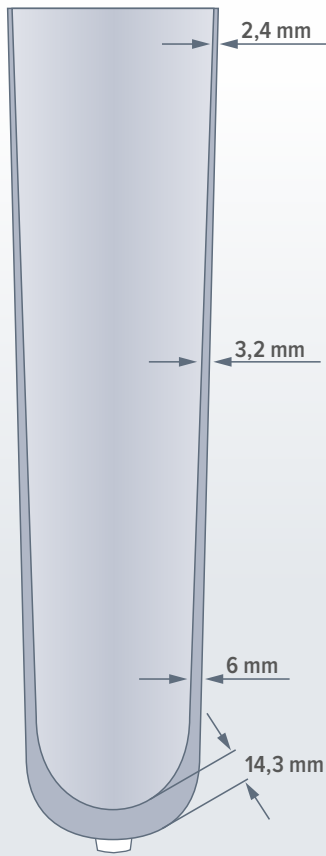

► Extra thickness of smooth silicone.

Technical data

Material Medical silicone

Length Aprox. 39 cm

Matrix

The matrix, designed to increase the stability of the distal tissues, thereby minimising the risks of injuries and providing maximum comfort, is located in the distal region. This distal reinforcement tissue limits the elongation and its subsequent piston effect when walking. Orliman liners have a 10 cm matrix that provides the necessary stability whilst limiting longitudinal stretching of the soft tissues of the stump when walking, especially during the balancing phase in which the prosthesis is fully suspended with a pendular movement.

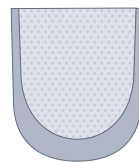

► 10 cm matrix.

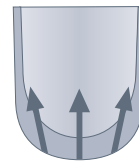

► Increased stability.

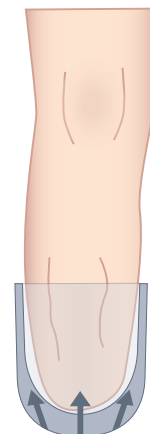

► Maximum comfort.

MAIN FEATURES



Distal cushioning

In order to increase the patient's skin comfort and care, especially in the scar region, the distal extreme of the liner is cushioned with an extra thick layer of soft silicone to provide the cushioning required to adapt to irregular scars, reducing rotational moments and distal impacts during loading.



Outer lining

The silicone liner has a textile lining in circular woven fabric provide a high strength lining that gives the liner long-term durability and absorbs the friction between the silicone and the rigid fitting, making it easier to put on and take off the prosthesis.



Medical silicone

High strength and easy to clean.





Model indicated for patients with low to moderate activity.

Ref.: LI1001

SILICONE TIBIAL LINER WITH PIN. SOFT



Model indicated for highly active patients.

Ref.: LI1002

SILICONE TIBIAL LINER WITH PIN. ACTIVE.

SIZES CM	20	22	23,5	25	26,5	28	30	32	34	36	38	40
----------	----	----	------	----	------	----	----	----	----	----	----	----

**Characteristics:**

Different densities are available depending on the patient's activity, thus providing the resistance and comfort demanded by amputees with different activities and characteristics.

**Indications:**

Indicated for patients with tibial amputations.

**Properties:**

- Manufactured in medical silicone.
- Matrix of 10 cm to stabilise the distal soft tissues.
- Distal umbrella designed to distribute the forces over the entire surface. Universal screwed orifice that allows it to be adapted to all kinds of suspension systems. (Shuttle locks).

**Size selection:**

Size selection is extremely important as an incorrect size could cause sweating and lack of precision when adapting the prosthesis and when walking; the stabilising matrix and distal umbrella should remain perfectly adapted to the stump. For this reason, Orliman has a broad range of sizes, from 20 up to 40 cm, to meet the requirements of different tibial stump morphologies.

For selection of the correct size measure on the patient's stump 4 cm proximally from the distal end. Then, select a size less than the measurement obtained and try it on the patient for them to check it before casting. A liner two sizes smaller is recommended for amputees undergoing their first prosthesis in anticipation of fast stump shrinkage and possible liner displacement.

**Colour:** ■ Blue.

**FUNCTIONS OF THE LINERS**

Silicone has the property of adhering closely to the skin and this manages to avoid irritations resulting from rubbing, dispersing the pressure areas from bone areas with the rigid laminated fitting. Because of its compression system it acts as a method to reduce oedema, while more specifically its functions are:

- Cushioning of sensitive areas and exostosis.
- Protection of skin, scars, etc.
- Cushioning of the impacts produced in the load area during the support phase when walking.
- Improved venous return by acting as a distal compression system.
- Stabilisation of the soft tissues of the stump, especially at the distal extreme.
- Balanced distribution of compression forces on the surface of the stump.
- Minimisation of the pressures in the distal region of the stump, providing padding for total contact fixings.
- As a prosthesis suspension method thanks to its combination with shuttle locks or similar systems.
- Reduction of the piston effect when walking.





Model indicated for patients with low to moderate activity.

Model indicated for highly active patients.

Ref.: LI1003

Ref.: LI1004

SILICONE TIBIAL LINER WITHOUT PIN. SOFT.

SILICONE TIBIAL LINER WITHOUT PIN. ACTIVE.

SIZES CM	20	22	23,5	25	26,5	28	30	32	34	36	38	40
----------	----	----	------	----	------	----	----	----	----	----	----	----

**Characteristics:**

Different densities are available depending on the patient's activity, thus providing the resistance and comfort demanded by amputees with different activities and characteristics.

**Indications:**

Indicated for patients with tibial amputations.

**Properties:**

Manufactured with high strength and easy to clean medical silicone. With a 14.3 mm distal pad for comfort and care of the patient's skin with an extra thickness of smooth silicone for extra cushioning, adapting to irregular scars, reducing rotational moments and distal impacts during loading. The outer sleeve of the liner is made of a circular knit fabric, providing it with a high strength coating that gives the liner prolonged durability and absorbs friction between the silicone and the fitting. In the distal zone is the matrix, the function of which is to increase the stability of the distal soft tissues, minimising the risk of injury and providing maximum comfort. To ensure proper function of the liner without pin in tibial prostheses, we recommend the use of the suspension system Orliman Ref: LI1005, composed of a Lycra-coated silicone knee brace.

**Colour:** ■ Blue.



Ref.: LI1005

SUSPENSION SYSTEM FOR TIBIAL PROSTHESES *Sleeves*

SIZES	PERIMETER CM
1	45-48
2	48-52
3	52-57
4	57-64



SIZES LI1005	SIZES LINERS
1	20-23,5
2	25-28
3	30-34
4	36-40

As guidance we have included a box with sizes of LINERS so that it is possible to know the correspondence with the suspension system.

**Characteristics:**

Lycra-coated silicone suspension system for tibial prostheses. Being made of silicone, it adheres to both the hard fitting of the prosthesis and the patient's thigh, providing a perfect fit between socket and stump and avoiding a sliding effect from the prosthesis. It also prevents the entry of air through the proximal part of the fitting, managing to maintain the vacuum required for the proper functioning of the prosthesis. The elasticity of the materials used allows great freedom of movement, even in knee flexion.

**Properties:**

The Orliman tibial suspension system provides the necessary adjustment for proper function of the tibial prosthesis; as it is made from silicone it grips the thigh as required in order to keep the prosthesis properly fitted. This, coupled with not allowing the entry of air through the proximal part of the fitting, prevents against sliding, thus reducing the friction between the stump and the hard fitting and protecting the stump against possible injury due to friction.

**Colour:** ■ Beige.





***SOFY-PLANT***<sup>®</sup>



 **ORLIMAN.** | *FeetPRO*

**MAIN FEATURES**

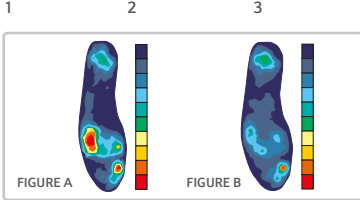
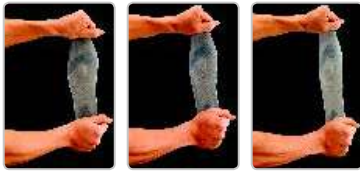

**MAXIMUM ELASTICITY silicone insoles**

The SOFY-PLANT silicone insoles unload the whole foot, especially the support areas of the metatarsals and the heel. Its two densities (one especially soft for the unloading areas) absorb shocks and impacts from the ground while walking, providing relief and comfort by avoiding pressure on the area of the heel and the metatarsals.

Especially indicated for tired, weak and delicate feet and in post-surgery situations. Also indicated for the practice of any sport that requires an extended effort.

Comparing figures A and B a significant reduction can be seen in the maximum pressure in the area of the heel and the top of the 5th metatarsal, moving from pressure maximums of 600Kpa to maximums of about 250 Kpa. SOFY-PLANT insoles and heelpieces are made of a notably pleasant material to touch and are made of 100% silicone, which makes them perfectly tolerable and easily washed with cold water and without any type of soap.



**Ref.: TL-601**

**SILICONE HEEL CUP**

SIZES	FOOTWEAR SIZE
1	35-38
2	39-42
3	43-46



**Units for packaging:** 1 pair.

**Characteristics:**

Due to their visco-elastic properties, these silicone heel cups cushion the load points both during walking and in static position.

**Indications:**

- Relieve talgalgia.
- Bursitis.
- Tendonitis of the Achilles tendon.

**Colour:**  Transparent.



**Ref.: TL-611**

**SILICONE HEEL CUP WITH CENTRAL SPUR**

SIZES	FOOTWEAR SIZE
1	35-38
2	39-42
3	43-46



**Units for packaging:** 1 pair.

**Characteristics:**

Due to their viscoelastic properties, these silicone heel supports cushion the load points both during walking and in static position. They have a circular area of softer consistency in the heel (blue area in).

**Indications:**

- Treatment of centralised calcaneus spur.
- Bursitis of the heel.
- Absorption of impacts.

**Colour:**  Transparent.



**Ref.: TL-612**

**SILICONE HEEL CUP WITH LATERAL SPUR**

SIZES	FOOTWEAR SIZE
1	35-38
2	39-42
3	43-46



**Units for packaging:** 1 pair.

**Characteristics:**

Due to their viscoelastic properties, these silicone heel supports cushion the load points both during walking and in static position. They have an oval area of softer consistency in the heel (blue area).

**Indications:**

- Lateralised spur.
- Bursitis of the heel.

**Colour:**  Transparent.



**Ref.: TL-613**

**ANATOMICAL SILICONE HEEL CUP FOR CENTRAL SPUR**

SIZES	FOOTWEAR SIZE
1	35-38
2	39-42
3	43-46



**Units for packaging:** 1 pair.

**Characteristics:**

Heel support made of silicone which, due to its viscoelastic properties, cushions the load points both during walking and in static position. It has an asymmetric area of softer consistency in the heel (blue zone). Base with anatomic form and greater width in the front part favouring the distribution of the loads between retroflex and half-flex, the control of the calcaneus and improves stability.

**Indications:**

- Treatment of calcaneus spur and bursitis of the heel.
- Tendonitis of the Achilles tendon.
- Plantar fasciitis and talgalgia.

**Colour:**  Transparent.



Ref.: TL-617-10 (10 mm) | Ref.: TL-617-05 (5 mm)

**FLAT SILICONE HEEL CUP WITH CENTRAL SPUR**

SIZES	FOOTWEAR SIZE
1	35-38
2	39-42
3	43-46
4	47-50



Units for packaging: 1 pair.

**Characteristics:**

Due to their viscoelastic properties, these silicone heel supports cushion the load points both during walking and in static position. They have a circular area of softer consistency in the heel (blue area). Without lateral edges and with a height of 10 mm (TL-617-10) and 5 mm (TL-617-05).

**Indications:**

- Treatment of centralised calcaneus spur.
- Bursitis of the heel and absorption of impacts.
- In lower member dysmetrias of 1 cm (TL-617-10) and 0.5 cm (TL-617-05).

Colour:  Transparent.



Ref.: TL-619

**SILICONE HEEL CUP FOR EXCESSIVE PRONATION OR SUPINATION**

SIZES	FOOTWEAR SIZE
1	35-38
2	39-42
3	43-46



Units for packaging: 1 pair.

**Characteristics:**

Silicone heel cup for excessive pronation or supination. It corrects heel deviation to improve posture and prevent disorders caused by poor positioning when walking.

**Indications:**

- For patients with excessive pronation or supination of the heels.

Colour:  Transparent.



Ref.: TL-620

**SILICONE PRONOSUPINATION HEEL CUP**

SIZES	FOOTWEAR SIZE
1	27-33
2	33-39
3	39-45



Units for packaging: 1 pair.

**Characteristics:**

Silicone heel cup for aligning the heel in pronation or supination. It corrects heel deviation to improve posture and prevent disorders caused by poor positioning when walking. Marked slant (18:7 mm).

**Indications:**

- Patients with excessive pronation or supination of the heel.

Colour:  Transparent.



Ref.: TL-618F

**LINED SILICONE HEEL CUP**

SIZES	FOOTWEAR SIZE
1	35-38
2	39-42
3	43-46



Units for packaging: 1 pair.

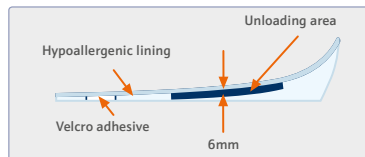

**Characteristics:**

Perfect housing for the heel due to its bowl shape and the hypoallergenic polyester fabric which improves comfort and breathability and impedes bacterial growth. Easy to wash. New attachment system that uses Velcro to stick to the footwear so it does not move. Ideal height which allows it to be adapted to any type of footwear. It is a long term product due to its greater silicone resistance. Made from 2 density silicone.

**Indications:**

- Provides swift relief for ligaments and muscles especially in excess load conditions.
- It is also suitable for bursitis and tendonitis of the Achilles Heel (impact absorption).

Colour:  Transparent and grey lining.



Ref.: PL-755

**LONG SILICONE INSOLE WITHOUT RETROCAPITAL SUPPORT**

SIZES	FOOTWEAR SIZE
0	35-36
1	37-38
2	39-40
3	41-42
4	43-44
5	45-46



Units for packaging: 1 pair.

**Characteristics:**

Insoles made with viscoelastic silicone with metatarsal and calcaneus supports in different density and with bridge.

**Indications:**

- Talalgia.
- Bursitis.
- Metatarsalgia.
- Calcaneus spur.
- Plantar fasciitis.
- Diabetic foot.
- Painful, tired or post-surgical feet. In sporting practice.

Colour:  Transparent.



**Ref.: PL-755F**

**LINED LONG SILICONE INSOLE WITHOUT RETROCAPITAL SUPPORT**

SIZES	FOOTWEAR SIZE
0	35-36
1	37-38
2	39-40
3	41-42
4	43-44
5	45-46



Units for packaging: 1 pair.

**Characteristics:**

Insoles made with viscoelastic silicone with metatarsal and calcaneus supports in different density and bridge. Lined with hypoallergenic fabric in polyester that prevents bacterial growth and is easily washable.

**Indications:**

- Talalgia and bursitis.
- Metatarsalgia.
- Calcaneus spur.
- Plantar fasciitis.
- Diabetic foot.
- Painful, tired or post-surgical feet. In sporting practice.

**Colour:**  Transparent and grey lining.



**Ref.: PL-750**

**SILICONE INSOLE**

SIZES	FOOTWEAR SIZE
0	35-36
1	37-38
2	39-40
3	41-42
4	43-44
5	45-46



Units for packaging: 1 pair.

**Characteristics:**

Insoles made with viscoelastic silicone with metatarsal and calcaneus supports in different density and with retrocapital support and bridge.

**Indications:**

- Talalgia and bursitis.
- Metatarsalgia and calcaneus spur.
- Plantar fasciitis and diabetic foot.
- Painful, tired or post-surgical feet. In sports.

**Colour:**  Transparent.



**Ref.: PL-750F**

**LINED SILICONE INSOLE**

SIZES	FOOTWEAR SIZE
0	35-36
1	37-38
2	39-40
3	41-42
4	43-44
5	45-46



Units for packaging: 1 pair.

**Characteristics:**

Insoles made with viscoelastic silicone with metatarsal and calcaneus supports in different density and with retrocapital support and bridge. Lined with hypoallergenic fabric in polyester that prevents bacterial growth and is easily washable.

**Indications:**

- Talalgia and bursitis.
- Metatarsalgia and calcaneus spur.
- Plantar fasciitis and diabetic foot.
- Painful, tired or post-surgical feet. In sporting practice.

**Colour:**  Transparent and grey lining.



**Ref.: PL-760**

**3/4 SILICONE INSOLE**

SIZES	FOOTWEAR SIZE
1	37-38
2	39-40
3	41-42
4	43-44



Units for packaging: 1 pair.

**Characteristics:**

Insoles made with viscoelastic silicone with metatarsal and calcaneus supports in different density and with bridge. The point of the foot is free.

**Indications:**

- Talalgia and bursitis.
- Metatarsalgia and calcaneus spur.
- Plantar fasciitis and diabetic foot.
- Painful, tired or post-surgical feet. In sporting practice.

**Colour:**  Transparent.



**Ref.: PL-760F**

**3/4 LINED SILICONE INSOLE**

SIZES	FOOTWEAR SIZE
1	37-38
2	39-40
3	41-42
4	43-44



Units for packaging: 1 pair.

**Characteristics:**

Insoles made with viscoelastic silicone with metatarsal and calcaneus supports in different density and with bridge. Lined with hypoallergenic fabric in polyester that prevents bacterial growth and is easily washable.

**Indications:**

- Talalgia and bursitis.
- Metatarsalgia and calcaneus spur.
- Plantar fasciitis and diabetic foot.
- Painful, tired or post-surgical feet. In sporting practice.

**Colour:**  Transparent and grey lining.



Ref.: PL-702

**INSOLE WITH METATARSAL ARCH**

SIZES	FOOTWEAR SIZE
1	34-36
2	37-39
3	40-42



Units for packaging: 1 pair.

**Characteristics:**

An insole made from superfine flexible viscoelastic silicone, which can adapt to most footwear due to its reduced thickness, and featuring a metatarsal arch that helps to align the metatarsal heads, providing pain relief to the forefoot and preventing the formation of calluses in people who spend considerable time standing or walking. The insole can be cut to fit the footwear.

**Indications:**

- Metatarsalgia and forefoot pain.

**Colour:**  Transparent.

Ref.: PL-701F

**LINED EXTRA-FINE INSOLE**

SIZES	FOOTWEAR SIZE
0	35-36
1	37-38
2	39-40
3	41-42
4	43-44
5	45-46



Units for packaging: 1 pair.

**Characteristics:**

Insoles made with flexible extra-fine viscoelastic silicone, which allows great adaptation to the majority of footwear due to thinness, with metatarsal and calcaneus supports in different density and with retrocapital support and bridge. Lined with hypoallergenic fabric in polyester that prevents bacterial growth and is easily washable.

**Indications:**

- Talgia and bursitis.
- Metatarsalgia and calcaneus spur.
- Plantar fasciitis and diabetic foot.
- Painful, tired or post-surgical feet. In sporting practice.

**Colour:**  Transparent and grey lining.



**Exhibitor**

Ref.: Exp-FINE-Cartón  
Units: 10  
Sizes: 34 x 25 cm



Ref.: PL-700F

**EXTRA-THIN LINED SILICONE INSOLES WITH METATARSAL PAD FOR LADIES**

SIZES	FOOTWEAR SIZE
1	34-36
2	37-39
3	40-42

Units for packaging: 1 pair.

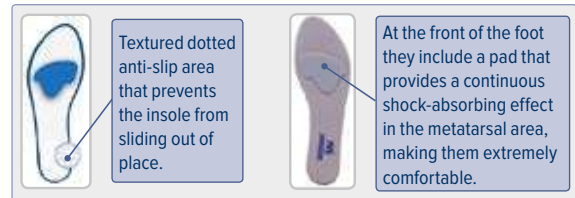

**Characteristics:**

Flexible extra-thin silicone insoles, with metatarsal pad which adapt perfectly to ladies shoes (high-heels or flats), due to their minimum thickness, ideal for all-day use. Lined with hypoallergenic polyester fabric that prevents bacterial growth, easy to clean. At the heel they incorporate an anti-slip system, preventing them from sliding out of place.

**Indications:**

- At the front of the foot they include a pad that provides a continuous damping effect in the metatarsal area, making them extremely comfortable.
- They relieve pain from the sole of the foot, preventing the formation of hard patches, they are shock-absorbing and reduce callusities.
- Pre-cut insoles.

**Colour:**  Transparent and grey lining.

**Exhibitor**

Ref.: Exp-FINE-Cartón  
Units: 14  
Sizes: 34 x 25 cm



Ref.: PS-17

**EXTRA-FINE SILICONE FOREFOOT CUSHION**

SIZES	ONE SIZE

Units for packaging: 1 pair.

**Characteristics:**

The forefoot cushions are made with flexible extra-fine silicone, which allows perfect adaptation to the shoe, throughout the medial area of the foot. Its design incorporates raised circles on the external side.

**Indications:**

- Provides pain relief of the metatarsal and forefoot area, preventing formation of calluses and hardness.

**Colour:**  Transparent.



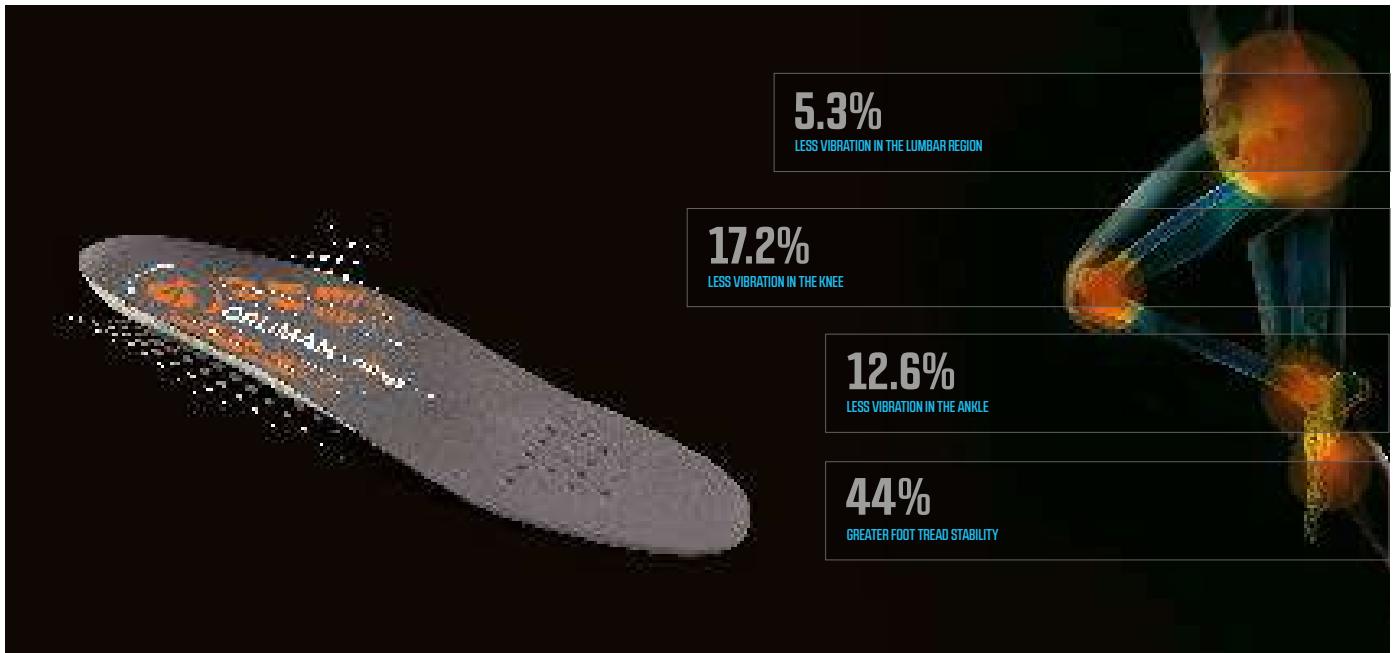

**Ref.: PL-BION**

**CUSTOM BIOMECHANICAL INSOLE TO PREVENT JOINT PAIN**

SIZES	36	37	38	39	40	41	42	43	44	45	46
-------	----	----	----	----	----	----	----	----	----	----	----

**Characteristics:**

A custom insole that can adapt to any type of foot. It can adapt to the anatomy of the foot to provide greater comfort when walking. 100% Total Dry. Composed of On Steam fabric - a microfibre that provides maximum breathability. It keeps the feet at the necessary temperature. Antibacterial treatment through the use of carbon.

**Indications:**

- Mild disorders in the biomechanics of the foot.
- Reduces vibration and joint pain.

**Colour:**  Grey.

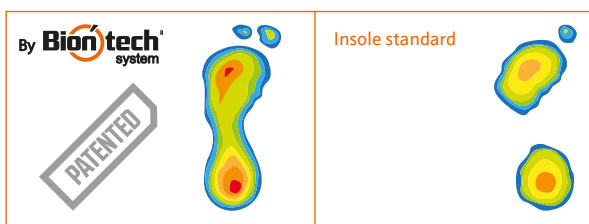

Before

After



**Exhibitor**

**Ref.: EXP-BION**  
Exhibitor Bion-Tech  
32x45 cm / 8 units



[▶ FITTING VIDEO](#)

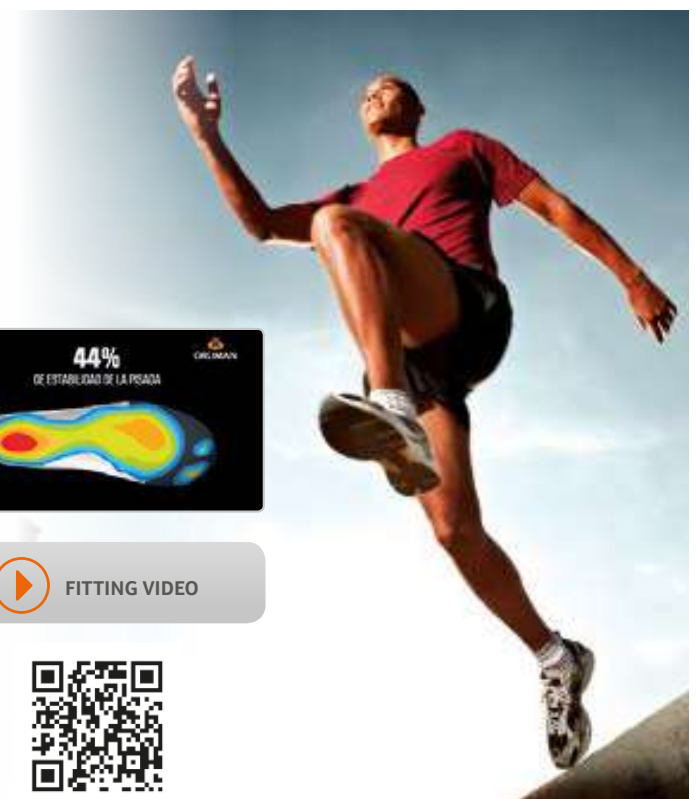

TECHNOLOGY AND DESIGN FOR THE WELLBEING OF THE FEET



Ref.: PL-710

DAILY ACTIVITY GEL INSOLES

SIZES	FOOTWEAR SIZE
1	36-39
2	40-43
3	44-47

Units for packaging: 1 pair.

Characteristics:

- ① Heel support: gel with anatomical design adapted to the heel for greater cushioning and improved momentum when walking.
- ② Plantar arch: thermoplastic elastomer structure with greater rigidity and an anatomical design.
- ③ Metatarsal support: gel with anatomical design adapted to the metatarsus or greater cushioning.
- ④ Contact insole: soft and breathable fabric with anti-bacterial treatment containing: Dimethyloctadecyl[3-(trimethoxysilyl)propyl]ammonium chloride, to prevent bad smells.

Indications:

Help to absorb impacts effectively and reducing pressure on the feet caused by everyday footwear and feeling comfortable and rested throughout the day. In addition to helping to provide greater stability and support to the plantar arch and cushioning to the metatarsus and heel. The sizing and adjustment system enables each size to be anatomically adapted to the appropriate shoe size. They can be used with everyday footwear.

Colour: ■ Blue.

Ref.: PL-720

INTENSE ACTIVITY GEL INSOLES

SIZES	FOOTWEAR SIZE
1	36-39
2	40-43
3	44-47

Units for packaging: 1 pair.

Characteristics:

- ① Heel support: thermoplastic elastomer gel with anatomical design for greater cushioning.
- ② Plantar arch: special thermoplastic PU structure for prolonged periods of standing with an anatomical design for increased stability and support in the arch and heel
- ③ Metatarsal support: perforated SBR pad with an anatomical design for a high degree of energy absorption, impact protection and improved momentum when walking.
- ④ Contact insole: High strength and breathable fabric with anti-bacterial treatment containing: Dimethyloctadecyl[3-(trimethoxysilyl) propyl] ammonium chloride, to prevent bad smells.

Indications:

Help to absorb impacts effectively and reduce the excessive pressure that the feet have to withstand during prolonged periods standing. They help provide reinforced stability and support to the plantar arch and cushioning to the metatarsus and heel. The sizing and adjustment system enables each size to be anatomically adapted to the appropriate shoe size. They can be used with everyday footwear.

Colour: ■ Grey.

**MAIN FEATURES**



Polymer gel: This is the name of a special mixture of polymers which are not toxic, to which a medicinal mineral oil has been incorporated.

▶ **POLYMER GEL TECHNOLOGY**

Thanks to the medicinal mineral oil which it contains, it hydrates, softens, protects and absorbs the affected area. Orliman Gels are transparent, not toxic, hypoallergenic, dermatologically tested and do not favor the growth of bacteria.

▶ **NUTRITIOUS ENVIRONMENT**

The specific gels based on the latest advances of Dermal Application Systems Technology provide a nutritious environment which favours healing and healthy skin.

▶ **WASHABLE AND REUSABLE**

All Orliman products are washable and reusable yet however they retain all their advantages. In fact, adequate cleaning and care contribute to a long life of the product.

▶ **CUSHIONS AND PROTECTORS**

Given the viscoelastic properties similar to those of fluids, our gels "flow" providing relief in situations of impact, sudden force, pressure, shock or vibration.

**NEW DISPLAY PODOLOGY**

**Exhibitor**

Ref.: EXP-SG  
Units: 60  
Sizes: 50x32 cm



FOOT  
ORLIMAN FEETPAD



Ref.: GL-100

**TOE SPREADERS**

SIZES	UNITS	
S	2	
M		
L		

▶ **Characteristics:**

Toe spreader made with non-toxic, hypoallergenic, dermatologically-tested, viscoelastic polymer gel that does not favour bacterial growth.

▶ **Indications:**

- Helps to preserve the alignment of the metatarsal phalangeal joint (ideal for the deformity of the bunion and deviation of the toe in post-operative care).
- Reduces friction, abrasion and irritation between adjacent or superimposed toes.

▶ **Colour:**  Transparent.



Ref.: GL-123

**TOE SPREADER WITH TOE LOOP**

SIZES	UNITS	
M	2	
L		

▶ **Characteristics:**

The toe separator with ring for the big toe separates the toes to help maintain correct alignment, prevent chafing and relieve pressure on the big toe joint and painful bunions. Anatomically moulded for comfortable insertion between the toes. The flexible ring on the big toe holds the toe separator in place. The gel slowly releases medical-grade mineral oil and vitamins to protect the skin.

▶ **Indications:**

- Aligns deviating toes.
- Relieves pressure on the metacarpophalangeal joint.
- Separates and protects the toes.
- Washable and reusable.
- Patented design.

▶ **Colour:**  Transparent.



Ref.: GL-101

**TOE SEPARATORS**

SIZES	UNITS	
S	2	
M		
L		
XL		

▶ **Characteristics:**

Half-moon separator made with nontoxic, hypoallergenic, dermatologically-tested, viscoelastic polymer gel that does not favour bacterial growth.

▶ **Indications:**

- Helps to protect against interdigit friction, abrasion and irritation caused by painful formations, such as spots, verrucas or ungual problems.
- Maintains alignment during healing for prolonged and post-operative use.

▶ **Colour:**  Transparent.





Ref.: GL-102

**PURE GEL BUNION SHIELD**



SIZES	UNITS	POLYMER GEL
S	2	
L		

**Characteristics:**

Protector shaped around the bunion made with non-toxic, hypoallergenic, dermatologically tested, viscoelastic polymer gel that does not favour bacterial growth.

**Indications:**

- The bunion protector cushions and protects the bony protuberance.
- Absorbs pressure and friction.

**Colour:**  Transparent.



Ref.: GL-124

**BUNION TOE SPREADER**



SIZES	UNITS	POLYMER GEL
ONE SIZE	1	

**Characteristics:**

The bunion toe spreader relieves pain caused by bunions and properly aligns the big toe. It absorbs stress placed on the metacarpophalangeal joint. Provides protection between big toe and shoe. The product slides easily over the big toe.

**Indications:**

- Reduces pressure and friction.
- Relieves bunion pain.
- Helps big toe realignment.
- Fits both feet.
- Patented design.

**Colour:**  Transparent.



Ref.: GL-122

**PURE GEL SIMPLE BUNION SHIELD**



SIZES	UNITS	POLYMER GEL
ONE SIZE	2	

**Colour:**  Transparent.



Ref.: GL-121

**BUNION RELIEF SLEEVE**



SIZES	UNITS	GEL INSIDE
S	1	
L		

**Characteristics:**

Absorbs shock and shear forces. The 3mm thin gel pad fits easily into shoes and other footwear. Soft, mineral oil gel softens and comforts painful and sensitive bunions (hallux valgus). The 3mm gel pad is in direct contact with the skin, moisturising and softening the skin. The comfort fabric secures comfortably over the big toe and around the foot, preventing sliding.

**Colour:**  Beige.



Ref.: GL-125

**DOUBLE LOOP BUNION SPREADER**



SIZES	UNITS	POLYMER GEL
ONE SIZE	1	

**Characteristics:**

Double loop tailor bunion spreader eases bunion pain and provides proper toe alignment. With two soft gel loops, the spreader stays in perfect position while reducing pressure on the MP Joint. Product easily slips over the 4th and 5th toes.

**Indications:**

- Tailor's bunion.
- Feet callus.

**Colour:**  Transparent.



**Ref.: GL-103**

**PROTECTIVE BUNION SHIELD IN GEL WITH FABRIC**



SIZES	UNITS	
S	1	
L		

**Characteristics:**

Protector that covers the area of the bunion, being placed on the toe. Made in viscoelastic polymer gel covered in elastic surgical fabric and with straps secured to the forefoot.

**Indications:**

- Cushions and protects the bony protuberance.
- Absorbs pressure and friction.

**Colour:** Beige.



**Ref.: GL-104**

**DIGITAL PADS**



SIZES	UNITS	
S	2	
M		
L		

**Characteristics:**

Ring-shaped cut tubes and with non-toxic, hypoallergenic, dermatologically tested viscoelastic polymer gel, which does not favour bacterial growth.

**Indications:**

- Relieves the pressure and friction of the affected toe.
- Contributes to reducing scar tissue.
- For ampoules, hammer toes, corns and toe traumas.

**Colour:** Beige.



**Ref.: GL-105**

**DIGITAL CAPS LINED**



SIZES	UNITS		
S	1		
M			
L			

**Characteristics:**

Protector that covers the area of the bunion, being placed on the toe. Made in viscoelastic polymer gel covered in elastic surgical fabric and with straps secured to the forefoot.

**Indications:**

- Cushions and protects the bony protuberance.
- Absorbs pressure and friction.

**Colour:** Beige.



**Ref.: GL-117**

**PURE GEL DIGITAL CAP**



SIZES	UNITS		
S	1		
M			
L			

**Characteristics:**

Tubular, toe-shaped, with non-toxic, hypoallergenic, dermatologically tested, viscoelastic polymer gel, which does not favour bacterial growth.

**Indications:**

- Helps relieve pressure and friction on the toes.
- Hammer toes, superimposed or infraposed toes.
- Keratotic injury or partially amputated toes.
- Skin or ungual problems due to dryness.

**Colour:**  Transparent.



**Ref.: GL-106**

**LINED GEL TUBING**



SIZES	UNITS	LENGTH		
XS	1	15		
S				
M				
L				

**Characteristics:**

15 cm tubes and with non-toxic, hypoallergenic, dermatologically tested, viscoelastic polymer gel that does not favour bacterial growth. They can be cut according to length.

**Indications:**

- Helps relieve pressure and friction.
- Protection and hydration of toes.
- It helps reduce scar tissue.

**Colour:** Beige.





Ref.: GL-107

**CORN PADS**



SIZES	UNITS	LENGTH
S	1	10
M		
L		

**Characteristics:**

10 cm tubes and with one side of non-toxic, hypoallergenic, dermatologically tested, viscoelastic polymer gel, which does not favour bacterial growth. They can be cut according to length.

**Indications:**

- Helps relieve pressure and friction.
- Protection and hydration of toes.
- It helps reduce scar tissue.

**Colour:**  Beige.





Ref.: GL-116

**PURE GEL TUBING**



SIZES	UNITS	LENGTH
S	1	15
M		
L		

**Characteristics:**

15cm tube of non-toxic, hypoallergenic, dermatologically-tested, viscoelastic polymer gel, which does not favour bacterial growth.

**Indications:**

- Helps relieve pressure and friction.
- Protection and hydration of toes.
- Helps to reduce scar tissue.

**Colour:**  Transparent.





Ref.: GL-118

**GEL FULLY COATED DIGITAL MESH TUBE**



SIZES	UNITS	LENGTH
S	1	15
M		
L		

**Characteristics:**

The fabric is fully lined with vitamin enriched gel. Helps relieve pain from corns, calluses, nail problems, dry cuticles and abrasions. The flexible mesh fabric stretches easily for ease of application. The gel will not flatten out, unlike foam products. The gel tubes can easily be cut to size. Washable and reusable.

**Colour:**  Beige.



Ref.: GL-115D RIGHT

Ref.: GL-115I LEFT

**PURE GEL TOE CREST**



SIZES	UNITS	
S	1	
M		
L		
FOOT		
R	L	

**Characteristics:**

Small pads of non-toxic, viscoelastic polymer gel with ring secured to 2nd toe and with protuberance that raises the head of the first metatarsal.

**Indications:**

- They provide relief for people with claw or hammer toes.
- They offer maximum comfort and reduce pressure on the toes and metatarsal heads.

**Colour:**  Transparent.



Ref.: GL-200

**METATARSAL CUSHION LINED**



SIZES	UNITS	
S	1 Pair	
L		

**Characteristics:**

Pad in non-toxic, viscoelastic polymer gel, with ring secured to 2nd toe, covered in elastic surgical fabric.

**Indications:**

- Protects the metatarsal area of the foot against friction and abrasion.
- Indicated in metatarsalgia.
- Helps to relieve the burning sensation and pain under the metatarsal heads.
- Relieves the rubbing of corns, small neuromas, and tarsal adipose cushions.
- It can be used as complement of soft cushion for metatarsalgia.

**Colour:**  Beige.



**Ref.: GL-201**

**PURE GEL METATARSAL CUSHION**



SIZES	UNITS
S	1 Pair
L	



**Characteristics:**

Pad with ring secured to 2nd toe, in non-toxic, viscoelastic polymer gel.

**Indications:**

- Protects the metatarsal area of the foot against friction and abrasion.
- Indicated in metatarsalgia which require an important unload.
- Helps to relieve the burning sensation and pain under the metatarsal heads.
- Relieves the rubbing of corns, small neuromas, and tarsal adipose cushions.
- It can be used as complement of soft cushion for metatarsalgia.

**Colour:**  Transparent.



**Ref.: GL-206**

**METATARSAL ELASTIC BAND WITH ELEVATION**

SIZES	SHOE SIZE	PERIMETER CM	UNITS
S	35-37	16-19	2
M	38-40	19-22	
L	41-43	22-26	

**Characteristics:**

Manufactured in stretch fabric, it provides support for the 2nd, 3rd and 4th metatarsals in the plantar area.

**Indications:**

Metatarsalgia, collapsed anterior arch of the foot (metatarsus latus).

**Colour:**  Beige.



**Ref.: GL-207**

**ELASTIC BAND**

SIZES	SHOE SIZE	PERIMETER CM	UNITS
S	35-37	16-19	2
M	38-40	19-22	
L	41-43	22-26	

**Characteristics:**

Manufactured in stretch fabric.

**Indications:**

Metatarsalgia, collapsed anterior arch of the foot (metatarsus latus).

**Colour:**  Beige.



**Ref.: GL-208**

**DRESS BUNION RELIEF SLEEVE WITH GEL METATARSAL PAD**

SIZES	UNITS
S	1 Pair
L	



**Characteristics:**

The sleeve is made from a fine stretch fabric and contains a polymer gel pad that cushions the metatarsal and bunion area. Discreet and non-slip. Can fit either foot.

**Indications:**

- Reduces pressure and friction.
- Eases bunion pain.
- Absorbs shock.
- Prevents the formation of corns and reduces calluses.
- Relieves pain in the metatarsal area.

**Colour:**  Beige.



**Ref.: GL-202D RIGHT**

**Ref.: GL-202I LEFT**

**METATARSAL ELASTIC BAND WITH GEL CUSHION**



SIZES	UNITS
S	1
L	



**Characteristics:**

Tubular elastic band to be placed on the forefoot. With separation for the first toe and with plantar cushion in non-toxic, viscoelastic polymer gel.

**Indications:**

- Designed to cushion the plantar area and the metatarsal head.
- Relieves plantar pain.
- Shock absorber. Reduces calluses.

**Colour:**  Beige.

**Ref.: FR-GL-202 D/I Metatarsal elastic band with cushion 2cm more longer than Ref: GL-202 D/I**



**Ref.: GL-203**

**GEL FOOT COVER**



SIZES	UNITS	
S	1 Pair	
M		
L		

**Characteristics:**

Forefoot protector in non-toxic, viscoelastic polymer gel coated with elastic surgical fabric.

**Indications:**

- Helps to retain the body temperature in the toes.
- Comforts and relieves symptoms in individuals suffering from arthritis or cold toes due to poor circulation.

**Colour:** Beige.



**Ref.: GL-300**

**COMPLETE FOOT PROTECTOR IN GEL PINKY WITH FABRIC**



SIZES	UNITS	
S 36-38	1 Pair	
M 39-41		
L 42-44		

**Characteristics:**

Non-toxic, viscoelastic polymer gel sock covered with elastic surgical fabric.

**Indications:**

- Ideal for tired feet.
- Ideal for diabetic feet.
- Helps to retain body temperature in the feet.
- Comforts or alleviates symptoms in those suffering from arthritis or cold toes due to poor circulation.

**Colour:** Beige.



**Ref.: GL-204** *Conforgel*

**MINI-PLANTAR BANDS WITH GEL**



SIZES	UNITS	
S <41	1 Pair	
L ≥41		

**Characteristics:**

Protect and relieve the pain in the metatarsal area, preventing the formation of hardness of the skin, shock absorber and reduces calluses.

**Indications:**

- The Mini plantars Conforgel bands, are manufactured with a fine elastic material and in the interior part they have a polymer gel cushion that provides a rapid relief to the metatarsal area.
- The minibands don't move.
- They are discreet and of sparse thickness, so you can use them in all kind of shoe.

**Colour:** Beige.



**Ref.: GL-205**

**TOE STRAIGHTENER DOUBLE TOE**

SIZES	UNITS
ONE SIZE	1

**Characteristics:**

The toe splint is the ideal solution to relieve pain caused by axial deviation, fractures or hammer toe. The splint helps to align the toes by means of adjustable rings while the soft double-layered anti-slip pad provides comfort for the metatarsal area of the foot.

**Indications:**

- Separates and aligns deformed, fractured and/or hammer toes.

**Colour:** Beige.





Ref.: PS-18

INVISIBLE FOREFOOT GEL MINIPADS.(SOFY-PLANT MINI)

SIZES	UNITS
ONE SIZE	1 Pair

**Characteristics:**

Maximum relaxation and total discretion; forget foot sole pain all day.

**Indications:**

- SOFY-PLANT MINI Invisible Forefoot Gel Minipads are designed to afford comfort and relief in the anterior region of the sole of the foot.
- They prevent the formation of corns and hardened areas, and offer anti-slipping characteristics and comfort.

**Colour:**  Transparent.

SELF ADHESIVE



Ref.: PS-19

INVISIBLE FOREFOOT ADHESIVE MINI PADS

SIZES	UNITS
ONE SIZE	1 Pair

**Characteristics:**

Relief of burning feet pain. Designed to absorb shock and pressure. Recommended for high heel shoes, sandals and boots. Provide all-day cushioning. Ultra slim to fit comfortably into shoes, sandals and boots. Durable. Transparent to match any shoe. Self adhesive. Non slip. Washable and re-usable. The gel pads will not compress like foams and felt products.

**Colour:**  Transparent.

SELF ADHESIVE



Ref.: PS-20

SANDAL SPREADER WITH TEARDROP

SIZES	UNITS
ONE SIZE	1 Pair

**Characteristics:**

Helps to reduce friction and irritation between the toes, ensuring maximum comfort. The pad provides comfort for the middle metatarsals. Absorbs shock and pressure. Slim design for maximum comfort. Self adhesive for easy fit. Stay in place. Transparent. Washable and reuseable. One size.

**Colour:**  Transparent.





**Exhibitor**

**Ref.: Exp-SF-Carton**  
Units: 10  
Sizes: 30 x 20 x 20cm



**SELF ADHESIVE**



**Ref.: PS-21**

**FLEXIBLE SELF ADHESIVE HEEL GRIPS**

SIZES	UNITS
ONE SIZE	1 Pair

**Characteristics:**

Washable, durable and hypoallergenic. The gel will not bottom out like foams. Ultra slim for easy fit. Self adhesive for easy fit. Transparent. Suitable for boots, shoes, and sandals. One size.

**Colour:**  Transparent.

**SELF ADHESIVE**



**Ref.: PS-22**

**3/4 LENGTH ADHESIVE GEL INSOLES WITH PRESSURE-RELIEF AREAS ON HEEL & FOREFOOT**

SIZES	UNITS
ONE SIZE	1 Pair

**Characteristics:**

3/4-length adhesive insoles with antislip invisible gel that absorb pressure and provide comfort for the feet when wear your favourite shoes (high heels or flats) all day long, whether you are at work or during your leisure time. The ultra-thin insoles adapt easily inside the shoes preventing the burning feeling on the feet. The strategically located pressure-relief areas provide additional cushioning under the heel and the forefoot. They absorb impacts and pressure. The adhesive prevents the insole from slipping and moving. Transparent. Washable and reusable. One size.

**Colour:**  Transparent.

**SELF ADHESIVE**



**Ref.: PS-23**

**ADHESIVE GEL HEEL CUSHIONS**

SIZES	UNITS
ONE SIZE	1 Pair

**Characteristics:**

Ultra-thin anti-slip transparent gel pads that easily adapt to the back part of the inside of your shoes to prevent that burning feeling under the heels, the pressure-relief area absorbs impacts and pressure. The adhesive prevents them slipping and moving.

**Colour:**  Transparent.



Ref.: HV-30 RIGHT | Ref.: HV-31 LEFT

## NIGHTTIME HALLUX-VALGUS CORRECTOR

SIZES	ONE SIZE	
-------	----------	---

### Characteristics:

Made in internal cotton bouclé in contact with the Beige. Comprises an abductor splint of moldable aluminium to regulate the position of the big toe. It covers the entire foot, and the perimeter can be regulated.

### Indications:

- Correction of the Hallux-Valgus posture.
- Post-surgical.

**Colour:** ■ Beige.



Ref.: HV-32

## DAYTIME HALLUX-VALGUS CORRECTOR

SIZES	FOOTWEAR SIZE
1	35-38
2	39-44



### Characteristics:

Comprises an elastic band around the instep and a cap for the big toe that is extended by an elastic band behind the Achilles tendon and fastens with Velcro for traction up to optimum position.

### Indications:

- Hallux- valgus correction.

**Colour:** ■ Beige.



Ref.: HV-33D RIGHT | Ref.: HV-33I LEFT

## HALLUX-VALGUS IN THERMOPLASTIC

SIZES	FOOTWEAR SIZE
1	34-36
2	37-40
3	41-46

### Characteristics:

Night-time corrector for bunions, manufactured in thermoplastic and velour, with micro-fastener seal. It includes a cushioning pad on the big toe which, together with the pressure strap, at the height of the bunion, maintains the first metatarsus aligned and in correct position during nighttime use, reducing pain and preventing its possible evolution.

### Indications:

- Hallux- valgus correction.

**Colour:** ■ Blue.



Ref.: HV-34

## conex<sup>®</sup> HALLUX VALGUS CORRECTOR

SIZES	ONE SIZE
-------	----------

Maximum half-foot perimeter: 30 cm.

### Characteristics:

Orthosis for dynamic correction of the position of the big toe. Comprising an elastic band that wraps around the midfoot and an elastic strap with gel that acts on the big toe through controlled pressure that promotes gradual valgus alignment. Its elasticity and malleability enable a dynamic action during walking and provide a perfect fit to the foot. The intensity of the correction is fully adjustable to the specific needs of each patient.

Comfortable and easy to fit, it can be used with any type of footwear. (Patented design).

### Effects:

- Hallux valgus correction.
- Post-surgical maintenance of the correction.
- Preventing the deformity from increasing.

### Indications:

- Correction of big toe valgus deformity;
- Pain relief by reducing capsule and ligament tension.
- Prevents the deformity from increasing by impeding incorrect biomechanical traction of the tendons.

### Colour:

■ Beige.



Ref.: CP01

## POST OPERATIVE SHOE

SIZES	FOOTWEAR SIZE
0	33-35
1	36-38
2	39-40
3	41-42
4	43-45

### Characteristics:

Made from breathable material and with an open toe, ideal for toe and forefoot surgery, with rigid reinforcement in the heel, ideal for heel afflictions.

### Indications:

- Post foot and toe operations, for cases of difficulties in venous return (oedemas), when conventional footwear cannot be used.

Colour: ■ Black.



Ref.: CP02

## POST-OPERATIVE TALIPES CALCANEUS SHOE

SIZES	FOOTWEAR SIZE
0	33-35
1	36-38
2	39-40
3	41-42
4	43-45

### Characteristics:

Made from breathable material and with an open toe, ideal for toe and forefoot surgery, with rigid reinforcement in the heel, ideal for heel afflictions.

### Indications:

- Post foot and toe operations, for cases of difficulties in venous return (oedemas), when conventional footwear cannot be used.
- Bandages that immobilise the tarsotibial joint, there by facilitating movement, especially in the lifting phase.

Colour: ■ Black.



Ref.: CP03

## HEEL SHOE TACO

SIZES	FOOTWEAR SIZE
1	35-37
2	38-40
3	41-43

### Characteristics:

Made from breathable material and with an open toe, ideal for toe and forefoot surgery, with rigid reinforcement in the heel, ideal for heel afflictions.

### Indications:

- Particularly indicated in foot surgery enabling the load to be placed on the heel and preventing the load on the front of the foot.

Colour: ■ Black.



Ref.: CP04

## POST-OPERATIVE SHOE (PARTICULARLY INDICATED FOR DIABETIC FOOT/ULCERS)

SIZES	FOOTWEAR SIZE
0	33-35
1	36-38
2	39-40
3	41-42
4	43-45

### Characteristics:

Universal to fit either the right or left foot, non-slip rocker sole, Velcro closure system enabling it to accommodate large deformities or post-operative dressings, made from a breathable material. The front of the shoe features a toe cap that can be attached or removed according to the needs of the patient. Its versatility enables its existing insole to be replaced by an active off-loading insole.

### Indications:

- Post-operative care of the foot and toes, in cases where it is not yet possible for the patient to wear conventional footwear due to venous return problems (oedema). Diabetic foot, plantar ulcers and other foot disorders when the off-loading insole is inserted.

Colour: ■ Black.

# Special insole for diabetic foot and ulcerations

## MAIN FEATURES

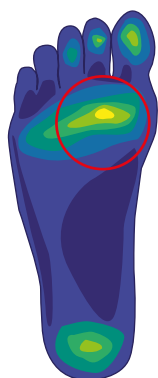

Overloading in the area of the ulcer (without insole)



Off-loading of the ulcer with the insole



Ref.: PANW (Walkers)



Ref.: PANCP (post-operative footwear)

## SPECIAL INSOLE FOR DIABETIC FOOT AND ULCERATIONS

### Ref.: PANW

INSOLE SIZE	SHOE SIZE			
	EST-083 / EST-086 / EST-089		EST-087 / EST-088	
1	≤37		36-39	
2		≤41		40-42
2			≤45	43-45

Equivalence chart for selecting the insole size that best fits each walker.

### Ref.: PANCP

SIZES	FOOTWEAR SIZE
0	33-35
1	36-38
2	39-40
3	41-42
4	43-45

Ref.: PANCP designed for post-operative footwear Ref.: CP04.

### Characteristics:

Composed of a velour base with a Velcro strip onto which is attached an insole consisting of hexagonal urethane (EVA) cells in 10 mm-thick slow-memory material, whose function is to relieve and reduce pressure areas, and a PORON lining that provides flexibility and the ability to absorb loads and impacts.

### Function:

The hexagonal cells that form the insole are moveable, making it possible to detach those that are in contact with the ulcerated area or the zone that requires pressure relief. As ulcers are often migratory, the cells can be replaced or removed according to their position and healing process stage in order to vary pressure points. Pressure and load forces can be reduced by up to 60% in all phases of static and dynamic loading.

### Indications:

- Plantar ulcers on the heel and forefoot.
- Neuropathies with the risk of plantar ulcers.
- Diabetic foot.
- Post-operative patients.
- Plantar warts after surgery.
- Plantar injuries.

### Colour:

- Maroon.



MAIN FEATURES



UNISEX



GRADUAL COMPRESSION



PROMOTES VENOUS RETURN



SEAMLESS



BREATHABLE



IVÁN RAÑA



Ref.: OV02D500 BLACK

Ref.: OV02D501 WHITE

SPORTS COMPRESSION SOCKS

SIZES	MEASURES	
	A-D cm HEIGHT	C cm MAXIMUM CALF CIRCUMFERENCE
1	36-40	30-34,5
2	36-40	34,5-39
3	36-40	39-43,5
4	36-40	43,5-48

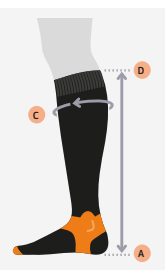

Ref.: OV02D500



Ref.: OV02D501

Characteristics:

- Improve venous return and muscle recovery.
- Reduce recovery time.
- Prevent against muscle injury.
- Allow the area to breathe and keep a constant temperature of the lower limbs.
- Provide greater protection for the most vulnerable areas (Achilles tendon, calves, toes and soles of the feet), minimising impact during sporting activities.
- Padded area at the top of the instep to avoid discomfort or chafing from shoes.

Composition:

72% Polyamide.  
28% Lycra.

Colour:

OV02D500: ■ Black.  
OV02D501: □ White.



MAIN FEATURES



UNISEX



GRADUAL COMPRESSION



PROMOTES VENOUS RETURN



SEAMLESS



BREATHABLE



FOOT  
ORLIMAN FEETPAD

Ref.: OV01D500 BLACK

TRAVEL SOCKS

SIZES	MEASURES	
	A-D cm HEIGHT	B cm MINIMUM ANKLE CIRCUMFERENCE
1	36-40	18-21,5
2	36-40	21,5-25
3	36-40	25-28,5
4	36-40	28,5-32

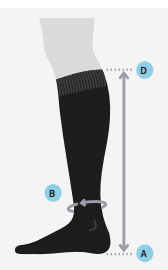

Characteristics:

- Stimulates and promotes venous return.
- Protects against possible impact injuries and abrasions on toes and heels.
- Recommended for long journeys.

Composition:

75% Polyamide.  
25% Lycra.

Colour:  Black.

DIABETIC SOCKS



MAIN FEATURES

DAILY, SOCK FOR EVERYDAY USE

RELAX



UNISEX



WITHOUT COMPRESSION



WITHOUT SEAMS



SMOOTH KNIT FABRIC



BREATHABLE



BACTERIOSTATIC



ANTI-ODOUR



DAILY

Ref.: OV04B000

**Composition:**  
85% Cotton with silver ions.  
12% Polyamide.  
3% Lycra.



RELAX

Ref.: OV03B005

**Composition:**  
40% Bamboo charcoal.  
40% Cotton with silver ions.  
16% Polyamide.  
4% Lycra.

Ref.: OV04B000 BLACK | Ref.: OV03B005 GREY

DIABETIC SOCKS

SIZES	MEASURES	
	SHOE SIZE	AB1 cm HEIGHT
1	36-38,5	18-22
2	38,5-41	18-22
3	41-43,5	18-22
4	43,5-46	18-22

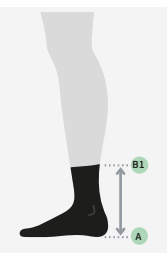

Characteristics:

- Prevent infections.
- Prevent the growth of bacteria and fungi (bacteriostatic treatment).
- Prevent chafing in delicate areas such as underneath the foot.
- Designed to prevent fungal infections and eczema.







### MAIN FEATURES

ORLIMAN® elaborates its thermal-grip garments with the best existing materials, fruit of the latest technological advances.  
All of its components have been tested to ensure unbeatable and a high quality of use.

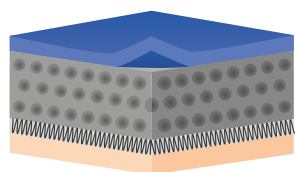

- Exterior Nylon layer
- Expanded rubber (Neoprene)
- Internal towel layer
- Skin

**F**

Fastening

**C**

Compression

**S**

Stabilisation

**I**

Inmobilization



Ref.: 4201

F .. C ... S .. I ..

**NEOPRENE BACK SUPPORT**

SIZES	PERIMETER CM	TROCHANTER
1	75-85	
2	85-95	
3	95-110	16 cm
4	110-125	28 cm

FRONT HEIGHT  
BACK HEIGHT

POSSIBILITY TO CUSTOMIZE

**Characteristics:**

Back support in 4,5 mm neoprene. Front fastening of 10 cm Velcro and 16 cm velour for easy fit and greater security. Four plastic rear stays for support.

**Indications:**

- Provides support during sporting activities.
- Prophylaxis in jobs with mechanical overload in the lumbosacral region.
- Non-specific lumbar pathologies and prevention of back injuries.

**Colours:**

4201: Blue.  
5201: Beige.



Ref.: 4202

F ... C ... S .. I ..

**REINFORCED NEOPRENE BACK SUPPORT**

SIZES	PERIMETER CM	TROCHANTER
1	75-85	
2	85-95	
3	95-110	16 cm
4	110-125	28 cm

FRONT HEIGHT  
BACK HEIGHT

POSSIBILITY TO CUSTOMIZE

**Characteristics:**

Back support in 3 mm neoprene with nylon outer layer and soft polyester towelling interior. Front fastening of Velcro for easy fit and greater security. With two expanding adjustment bands to provide greater compression.

**Indications:**

- Lumbalgia.
- Rheumatic pains.
- Activities that require continued overexertion.

**Colours:**

4202: Blue.  
5202: Beige.



Ref.: 4203

F ... C ... S .. I ..

**CROSSED NEOPRENE BACK SUPPORT WITH CUSHION**

SIZES	PERIMETER CM	TROCHANTER
1	75-85	
2	85-95	
3	95-110	16 cm
4	110-125	28 cm

FRONT HEIGHT  
BACK HEIGHT

POSSIBILITY TO CUSTOMIZE

**Characteristics:**

Back support in 4,5 mm neoprene. Steel stays, rear crossed bands with Velcro front fastening and mouldable lumbar cushion.

**Indications:**

- Lumbago and lumbosciatica.
- Rheumatic pains.
- Lumboarthrosis.
- Atonic muscles and degenerative processes.
- Strong containment in activities that require continued exertion.
- Mouldable cushion allowing greater relief of the lumbar area.

**Colours:**

4203: Blue.  
5203: Beige.



Ref.: 4204

F .. C .. S . I .

**NEOPRENE ABDOMINAL BAND**

SIZES	ONE SIZE
FRONT HEIGHT	24 cm
BACK HEIGHT	24 cm

POSSIBILITY TO CUSTOMIZE

**Characteristics:**

Band for light lumboabdominal support without reinforcements.

**Indications:**

- Lumbar symptoms.
- Slight lumbalgia.
- Individuals requiring gentle containment.

**Colours:** Blue.



Ref.: 4205

F ... C ... S ... I ...

**NEOPRENE LUMBOSACRAL SUPPORT**

SIZES	PERIMETER CM	TROCHANTER
1	75-85	
2	85-95	
3	95-110	16 cm
4	110-125	28 cm

FRONT HEIGHT  
BACK HEIGHT

POSSIBILITY TO CUSTOMIZE

**Characteristics:**

Crossed bands in the posterior area and flexible plates.

**Indications:**

- Lumbar symptoms. Slight lumbalgia. Weak and atonic muscles.

**Colours:**

4205: Blue.

# Thermo-med®

Wrist support Thermo-compression Orthoses



Ref.: 4601 RIGHT    Ref.: 4602 LEFT

F .. C ... S . I .

## NEOPRENE SPLINT WRIST SUPPORT

SIZES	PERIMETER CM
1	15-17
2	17-19
3	19-21
4	21-23



### Characteristics:

3 mm neoprene wrist support with removable and moldable semi-spherical aluminium palm support and Velcro fasteners.

### Indications:

- Instability by mild traumas.
- Tendonitis.
- Arthritis.

### Colours:

4601-4602: ■ Blue.  
5601-5602: ■ Beige.



Ref.: 4604

F .. C ... S . I .

## NEOPRENE THUMB WRIST SUPPORT

SIZES	PERIMETER CM
1	15-17
2	17-19
3	19-21
4	21-23



### Characteristics:

3 mm neoprene wrist support, with Velcro fastening and moldable thumb splint.

### Indications:

- Immobilisation and protection of the carpometacarpal and metacarpophalangeal joints.
- Slight wrist instabilities.
- Protection during sporting activities.

### Colours:

4604: ■ Blue.  
5604: ■ Beige.

# Thermo-med®

Shoulders Thermo-compression Orthoses



Ref.: 4801 RIGHT    Ref.: 4802 LEFT

F .. C .... S .. I .

## NEOPRENE SHOULDER SUPPORT

SIZES	PERIMETER CM A	PERIMETER CM B
2	32-40	20-25
3	40-48	25-30
4	48-56	30-35

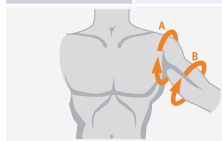

### Characteristics:

Sleeve-shaped Neoprene shoulder support fastening under the contralateral arm.

### Indications:

- Subluxations of the scapulo-humeral joint.
- Slight instabilities.
- Long-term painful processes.

### Colours:

4801-4802: ■ Blue.  
5801-5802: ■ Beige.



Ref.: 4803

F .. C .... S .. I .

## NEOPRENE BILATERAL SHOULDER SUPPORT

SIZES	PERIMETER CM A	PERIMETER CM B
2	32-40	20-25
3	40-48	25-30
4	48-56	30-35

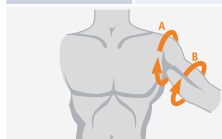

### Characteristics:

Double neoprene shoulder support in waistcoat shape and with front Velcro fastening.

### Indications:

- Subluxations of the scapulo-humeral joint.
- Slight instabilities.
- Long-term painful processes.
- Prevention in sports or activities where the joint is subject to overexertion.

### Colours:

4803: ■ Blue.  
5803: ■ Beige.



Ref.: 4300

F .. C ... S .. I .

**NEOPRENE ELBOW SUPPORT**

SIZES	PERIMETER CM	
1	21-24	<p>Perimeter in cm around centre of elbow.</p>
2	24-26	
3	26-29	<p>HEIGHT 22 cm</p>
4	29-32	
5	32-35	<p>POSSIBILITY TO CUT</p>

**Characteristics:**

3 mm neoprene elbow support with shape and trimming parts in the distal areas to avoid migration of the garment.

**Indications:**

• Prevention of sporting injuries.

**Colours:**

4300: Blue.  
5300: Beige.



Ref.: 4301

F ... C ... S ... I ..

**NEOPRENE EPICONDYLITIS ELBOW SUPPORT**

SIZES	PERIMETER CM	
1	21-24	<p>Perimeter in cm around centre of elbow.</p>
2	24-26	
3	26-29	<p>HEIGHT 23 cm</p>
4	29-32	
5	32-35	<p>POSSIBILITY TO CUT</p>

**Characteristics:**

3 mm neoprene elbow support with Velcro strap that applies pressure at the level of the epicondyle and has two interchangeable cushions.

**Indications:**

• Epicondylitis (tennis elbow).  
• Epitrochleitis. (golfer's elbow).

**Colours:**

4301: Blue.  
5301: Beige.



Ref.: 4303

F .. C ... S .. I .

**NEOPRENE PADDED ELBOW SUPPORT**

SIZES	PERIMETER CM	
1	21-24	<p>Perimeter in cm around centre of elbow.</p>
2	24-26	
3	26-29	<p>HEIGHT 22 cm</p>
4	29-32	
5	32-35	<p>POSSIBILITY TO CUT</p>

**Characteristics:**

3 mm neoprene elbow support with reinforcement area in 3 mm. It has shape and trimming parts in the distal areas to prevent migration of the garment.

**Indications:**

• Recommended for sporting activities.

**Colours:**

4303: Blue.  
5303: Beige.





Ref.: 4100

F .. C ... S . I .

**CLOSED NEOPRENE KNEE SUPPORT**

SIZES	PERIMETER CM
1	32-34
2	34-36
3	36-38
4	38-41
5	41-44
6	44-49

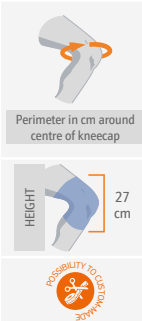

- Characteristics:** 4,5 mm neoprene knee support with closed kneecap.
- Indications:**
  - Minor contusions.
  - Arthrosis and arthritis.
  - Post-surgical treatments.
  - Rehabilitation.
  - Thermocompression, relief and protection.
- Colours:**
  - 4100: Blue.
  - 5100: Beige.



Ref.: 4101

F .. C ... S . I .

**NEOPRENE KNEE SUPPORT WITH OPEN KNEECAP**

SIZES	PERIMETER CM
1	32-34
2	34-36
3	36-38
4	38-41
5	41-44
6	44-49



- Characteristics:** 4,5 mm neoprene knee support with open kneecap.
- Indications:**
  - Light contusions.
  - Arthrosis and arthritis.
  - Post-surgical treatments.
  - Rehabilitation.
  - Any knee pathology requiring the centring or relief of the kneecap.
  - Thermocompression, relief, protection and centring of the kneecap.
- Colours:**
  - 4101: Blue.
  - 5101: Beige.



Ref.: 4102

F .. C ... S .. I ..

**NEOPRENE KNEE SUPPORT WITH FLEXIBLE LATERAL STABILISERS**

SIZES	PERIMETER CM
1	32-34
2	34-36
3	36-38
4	38-41
5	41-44
6	44-49

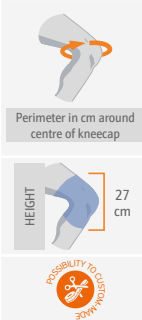

- Characteristics:** 4,5 mm neoprene knee support with open kneecap and spiral reinforcement stays for lateral stabilisation. With interchangeable kneecap padding.
- Indications:**
  - Minor contusions.
  - Arthrosis and arthritis.
  - Post-surgical treatment.
  - Rehabilitation.
  - Any knee pathology requiring the centring or relief of the kneecap.
  - Thermocompression, relief, protection, mediolateral stability and centring of the kneecap.
- Colours:**
  - 4102: Blue.
  - 5102: Beige.



Ref.: 4103

F .. C ... S .. I ..

**NEOPRENE KNEE SUPPORT WITH FLEXIBLE LATERAL STABILISERS AND SECURING STRAPS**

SIZES	PERIMETER CM
1	32-34
2	34-36
3	36-38
4	38-41
5	41-44
6	44-49

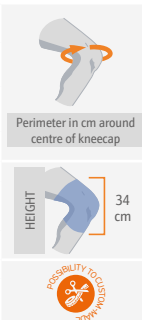

- Characteristics:** 4,5 mm neoprene knee support with flexible lateral stabilisers and upper and lower adjustment straps. Interchangeable patellar pad.
- Indications:**
  - Light contusions.
  - Arthrosis and arthritis.
  - Post-surgical treatments. Rehabilitation.
  - Thermocompression, relief, protection, optimum stabilisation of the articulation, permanent centring of the kneecap.
- Colours:**
  - 4103: Blue.
  - 5103: Beige.



**Ref.: 4103-A**

F .. C ... S .. I ..

**NEOPRENE KNEE SUPPORT WITH THIGH AND CALF OPENINGS FLEXIBLE LATERAL STABILISERS AND ADJUSTMENT STRAPS**

SIZES	PERIMETER CM
1	32-34
2	34-36
3	36-38
4	38-41
5	41-44
6	44-49



**Characteristics:**

4,5 mm neoprene knee support with flexible lateral stabilisers and upper and lower adjustment straps. Interchangeable patellar pad. Easy to fit and remove thanks to the thigh and calf openings.

**Indications:**

- Light contusions.
- Arthrosis and arthritis.
- Post-surgical treatments. Rehabilitation.
- Thermo-compression, relief, protection, stability, centring of the kneecap, adaptation to specific anatomies.

**Colours:**

4103-A: ■ Blue.  
5103-A: ■ Beige.



**Ref.: 4104**

F .. C ... S ... I ...

**NEOPRENE KNEE SUPPORT WITH POLYCENTRIC HINGE AND ADJUSTMENT STRAPS**

SIZES	PERIMETER CM
1	32-34
2	34-36
3	36-38
4	38-41
5	41-44
6	44-49



**Characteristics:**

4,5 mm neoprene knee support with metallic bands with polycentric articulation and upper and lower adjustment straps. Interchangeable patellar cushion. Calf opening.

**Indications:**

- Light contusions.
- Arthrosis and arthritis.
- Post-surgical treatments. Rehabilitation.
- Capsuloligamentous and medio-lateral instabilities.
- Thermo-compression, relief, protection, stability, permanent centring of the kneecap.

**Colours:**

4104: ■ Blue.  
5104: ■ Beige.



**Ref.: 4104-A**

F .. C ... S ... I ...

**NEOPRENE KNEE SUPPORT WITH POLYCENTRIC HINGE AND THIGH CALF OPENINGS**

SIZES	PERIMETER CM
1	32-34
2	34-36
3	36-38
4	38-41
5	41-44
6	44-49



**Characteristics:**

4,5 mm neoprene knee support with metallic bands with polycentric articulation and upper and lower adjustment straps. Interchangeable patellar pad. Easy to fit and remove thanks to the thigh and calf openings.

**Indications:**

- Ligament instabilities.
- Arthrosis and arthritis.
- Post-surgical treatments. Rehabilitation.
- Thermo-compression, relief and protection, medio-lateral stability and centring of the kneecap.

**Colours:**

4104-A: ■ Blue.  
5104-A: ■ Beige.



**Ref.: 4105**

F .. C ... S .. I ..

**NEOPRENE KNEE SUPPORT FLEXIBLE LATERAL STABILISERS AND SILICONE KNEEPAD**

SIZES	PERIMETER CM
1	32-34
2	34-36
3	36-38
4	38-41
5	41-44
6	44-49



**Characteristics:**

4,5 mm neoprene knee support with open kneecap and spiral reinforcement stays for lateral stabilisation. With silicone kneepad.

**Indications:**

- Femoropatellar injuries.
- Arthrosis and arthritis.
- Post-surgical treatment.
- Subluxations of the kneecap.
- Chondromalacia of the kneecap.
- Thermo-compression, relief, protection, micromassage of soft articulated areas and centring of the kneecap.

**Colours:**

4105: ■ Blue.  
5105: ■ Beige.



Ref.: 4106

F • C •• S • I •

**NEOPRENE PADDED KNEE SUPPORT**

SIZES	PERIMETER CM
1	32-34
2	34-36
3	36-38
4	38-41
5	41-44
6	44-49



**Characteristics:**

4,5 mm neoprene padded knee support.

**Indications:**

- In processes requiring heat and compression.
- Traumas.
- Inflammations.
- Arthritis.
- Post-surgical treatment.
- Rehabilitation.
- Bursitis.
- Acute and chronic knee complaints.
- Prevention in work involving knee-bending and kneecap loading.

**Colours:**

4106: ■ Blue.  
5106: ■ Beige.



Ref.: 4109

F •• C ••• S •• I ••

**NEOPRENE KNEE SUPPORT CROSSED LIGAMENTS**

SIZES	PERIMETER CM
1	32-34
2	34-36
3	36-38
4	38-41
5	41-44
6	44-49



**Characteristics:**

4,5 mm neoprene knee support with open kneecap, interchangeable patellar pad, adjustment strap and lateral stabilisers. Calf opening.

**Indications:**

- Kneecap distensions.
- Instability of crossed and lateral knee ligaments.

**Colours:**

4109: ■ Blue.  
5109: ■ Beige.



Ref.: 4110

F • C •• S • I •

**NEOPRENE INFRAPATELLAR STRAP**

SIZES	ONE SIZE



**Characteristics:**

Infrapatellar compression pad with Velcro fastening.

**Indications:**

- Osgood-Schlatter disease.

**Colour:** ■ Blue.



Ref.: 4111

F •• C ••• S •• I •

**NEOPRENE KNEECAP SUPPORT**

SIZES	PERIMETER CM
1	32-34
2	34-36
3	36-38
4	38-41
5	41-44
6	44-49



**Characteristics:**

4,5 mm neoprene kneecap support with infrapatellar Velcro fastening and patellar opening. Incorporates a compression tube to compress the kneecap ligament, before its insertion in the tuberosity of the tibia, this way minimising the mechanic strains.

**Indications:**

- Osgood-Schlatter disease.
- Chondromalacia of the kneecap.

**Colours:**

4111: ■ Blue.  
5111: ■ Beige.



Ref.: 4112 SHORT | Ref.: 4113 LONG

F ... C ... S .... I .....

**NEOPRENE KNEE SUPPORT FOR FLEXION-EXTENSION CONTROL**

SIZES	PERIMETER CM
1	32-34
2	34-36
3	36-38
4	38-41
5	41-44
6	44-49

Perimeter in cm around centre of kneecap

HEIGHT

4112: 35 cm  
4113: 45 cm  
5112: 35 cm  
5113: 45 cm

POSSIBILITY TO CUSTOMIZE

**Characteristics:**

4,5 mm neoprene knee support with polycentric articulation of 0-15- 30-60-90 degrees of flexion-extension. Velcro calf and thigh fastenings, popliteal openings (1 adjustment strap on thigh and 1 on calf in Ref. 4112), (2 adjustment straps on thigh and 2 on calf on ref. 4113). With interchangeable patellar cushion.

**Indications:**

- Post-operative and post-surgical treatment of the knee.
- Rehabilitation after injuries.
- To obtain a range of control of the mobility of the operated knee (crossed ligament surgery).

**Colours:**

4112/4113: ■ Blue.  
5112/5113: ■ Beige.



Ref.: 4116

F .. C ... S .. I ..

**NEOPRENE STABILISER KNEE SUPPORT WITH SILICONE KNEEPAD, LATERAL FLEXIBLE STABILISERS AND ADJUSTMENT STRAPS**

SIZES	PERIMETER CM
1	32-34
2	34-36
3	36-38
4	38-41
5	41-44
6	44-49

Perimeter in cm around centre of kneecap

HEIGHT 34 cm

POSSIBILITY TO CUSTOMIZE

**Characteristics:**

4,5 mm neoprene knee support with open kneecap and spiral reinforcement stays for lateral stabilisation. With silicone kneepad and straps with elastic portion for better adjustment. Rear thigh and calf opening with Velcro for better adaptation.

**Indications:**

- Functional treatment in distensions, instabilities and contusions.
- Arthrosis and arthritis.
- The upper and lower openings lighten excessive pressures.

**Colours:**

4116: ■ Blue.  
5116: ■ Beige.







Ref.: 4400

F .. C .. S .. I ..

**CLOSED NEOPRENE ANKLE SUPPORT**

SIZES	PERIMETER CM
1	22-24
2	24-26
3	26-28
4	28-31
5	31-34



**Characteristics:**

3 mm neoprene ankle support with trimming parts in the upper part for better adjustment.

**Indications:**

- Slight sprains.
- Tendonitis.
- Post-operatives.
- Relapses.

**Colours:**

4400: Blue.  
5400: Beige.



Ref.: 4401

F ... C ... S ... I ...

**NEOPRENE CROSSOVER ELASTIC ANKLE SUPPORT**

SIZES	PERIMETER CM
1	22-24
2	24-26
3	26-28
4	28-31
5	31-34



**Characteristics:**

3 mm neoprene ankle support with Velcro adjustment straps in the upper part. Elastic adjustment strap in Velcro and velour to control the pronation and supination of the ankle.

**Indications:**

- Slight sprains.
- Tendonitis.
- Post-operatives and relapses.

**Colours:**

4401: Blue.  
5401: Beige.



Ref.: 4402

F .. C ... S .. I ..

**OPEN NEOPRENE ANKLE SUPPORT**

SIZES	PERIMETER CM
1	22-24
2	24-26
3	26-28
4	28-31
5	31-34



**Characteristics:**

3 mm neoprene ankle support with velcro adjusters in the upper part.

**Indications:**

- Slight sprains.
- Tendonitis.
- Post-operatives and relapses.

**Colours:**

4402: Blue.  
5402: Beige.



Ref.: 4403

F .. C ... S .. I ..

**NEOPRENE ANKLE SUPPORT WITH ZIP**

SIZES	PERIMETER CM
1	22-24
2	24-26
3	26-28
4	28-31
5	31-34



**Characteristics:**

3 mm neoprene ankle support with lateral zip to facilitate adjustment and adaptation.

**Indications:**

- Slight sprains.
- Tendonitis.
- Post-operatives and relapses.
- When there is inflammation or oedema that impedes placement.

**Colours:**

4403: Blue.  
5403: Beige.



Ref.: 4404

F .. C ... S ... I ..

**ANKLE SUPPORT WITH THERMOPLASTIC PLATES**

SIZES	PERIMETER CM
1	22-24
2	24-26
3	26-28
4	28-31
5	31-34



**Characteristics:**

3 mm neoprene ankle support with crossed band and removable internal and external plastic malleolar plates. The plates can be placed on the left side as well as on the right, therefore to avoid rubbing and discomfort during fitting the plates have been labelled as internal and external.

**Indications:**

- Ligamentous instability.
- Tendonitis.
- Post-operatives and relapses.

**Colours:**

4404: Blue.  
5404: Beige.



Ref.: 4406

F ... C ... S ... I ...

**ANKLE STABILISER IN NEOPRENE WITH DOUBLE MEDIOLATERAL SUPPORTS**

SIZES	PERIMETER CM
1	22-24
2	24-26
3	26-28
4	28-31
5	31-34



Over malleolus



**Characteristics:**

3 mm neoprene ankle support with elastic strapping and mediolateral support. Bilateral ankle support with zip fasteners, making it easier for people with swollen or weak ankles, as well as those suffering rheumatoid arthritis, etc.

**Colour:** Blue.



Ref.: 4500

F ... C ... S ... I ...

**NEOPRENE THIGH SUPPORT**

SIZES	PERIMETER CM
1	45-48
2	48-52
3	52-57
4	57-64



Perimeter in cm of thigh



**Characteristics:**

3 mm neoprene thigh support. With elastic distal straps made in conical shape adapted to the different circumferences of the thigh.

**Indications:**

- Prevention of muscular tears, mainly in quadriceps and abductors.

**Colours:**

4500: Blue.  
5500: Beige.



Ref.: 4700

F ... C ... S ... I ...

**NEOPRENE TROUSERS**

SIZES	PERIMETER CM
1	75-85
2	85-95
3	95-105
4	105-115



TROCHANTER



**Characteristics:**

2 mm neoprene trousers ideal for sports. Front zip fastener for ease of adjustment.

**Indications:**

- Ideal for preventing sports injuries.
- Overload situations.
- Inguinal problems.

**Colours:**

4700: Blue.  
5700: Beige.



Ref.: 4701

F ... C ... S ... I ...

**HIGH NEOPRENE TROUSERS**

SIZES	PERIMETER CM
1	75-85
2	85-95
3	95-105
4	105-115



TROCHANTER



**Characteristics:**

2 mm neoprene trousers ideal for sports. With sufficient height to provide heat to the lumbar muscles and increase sweating in this area. Frontal zip fastener for ease of adjustment.

**Indications:**

- Ideal for preventing sports injuries especially in those with weakness in the lumbar muscles.
- Situations of overload.
- Inguinal problems.

**Colours:**

4701: Blue.  
5701: Beige.



Ref.: 4702

F ... C ... S . I .

**SHORT NEOPRENE TROUSERS**

SIZES	PERIMETER CM
1	75-85
2	85-95
3	95-105
4	105-115

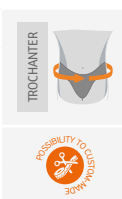

**Characteristics:**

2 mm neoprene trousers ideal for sports. Without fasteners, being a short model and in elastic material they adapt to any anatomy.

**Indications:**

- Ideal for preventing sports injuries.
- Relief situation.
- Inguinal problems.

**Colour:** ■ Blue.



Ref.: 4800

F ... C ... S . I .

**NEOPRENE CALF SUPPORT**

SIZES	PERIMETER CM
1	27-29
2	29-32
3	32-35
4	35-39

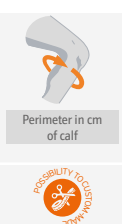

**Characteristics:**

3 mm neoprene calf support. With elastic distal straps, conical shape that is adapted to the different calf anatomies.

**Indications:**

- Indicated in muscular pathologies.
- For protection of the anterior spine of the tibia.

**Colours:**

4800: ■ Blue.  
5800: ■ Beige.



Ref: 5501 RIGHT | Ref: 5502 LEFT

F .. C . S ... I .

**NEOPRENE SUPPORT BELT FOR FEMURAL PROTHESIS**

SIZES	PERIMETER CM A	PERIMETER CM B
2	85-100	40-50
3	85-110	48-58
4	105-125	56-66

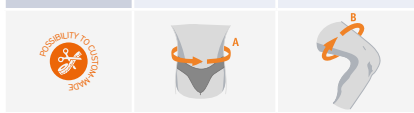

**Characteristics:**

3 mm neoprene thigh support. With elastic distal straps made in conical shape adapted to the different circumferences of the thigh.

**Indications:**

- Prevention of muscular tears, mainly in quadriceps and abductors.

**Colour:** ■ Beige.

THERA GO® | SPORT | FIXOQUICK | NEOPREN | ONE PLUS | ELASTIC





**Exhibitor**

Ref.: Exp-ONE-Cartón  
Units: 14  
Sizes: 48 x 50 x 30 cm



**Ref.: 4119**

F .. C ... S .. I .

**NEOPRENE OPEN KNEE SUPPORT**

SIZES	ONE SIZE
<p>HEIGHT 27 cm</p>	<p>POSSIBILITY TO CUSTOMIZE</p>

**Characteristics:**

The stabilising one size kneecap support enables tension control by means of adjustable bands that favour a perfect adaptation to the kneecap, without bothering the polpíteal area. Made from 2 mm astrakhan neoprene, with thermal properties that relieve pain and favour recovery and maintain the flexibility of the joints. It is light and comfortable for a daily use.

**Indications:**

- Light contusions.
- Arthrosis and arthritis.
- Post-surgical treatment.
- Rehabilitation.
- Any knee pathology in which centring or unloading of the kneecap is necessary.

**Colour:** ■ Blue.



**Ref.: 4405**

F .. C .. S . I .

**NEOPRENE ANKLE SUPPORT**

SIZES	ONE SIZE
	<p>POSSIBILITY TO CUSTOMIZE</p>

**Characteristics:**

The stabilising one size ankle support enables tension control by means of adjustable bands that favour a perfect adaptation both in the instep as in the calcaneus. Made from 2 mm astrakhan neoprene, with thermal properties that relieve pain and favour recovery and maintain the flexibility of the joints. It is light and comfortable for a daily use.

**Indications:**

- Slight sprains.
- Tendonitis.
- Post-operatives.
- Relapses.

**Colour:** ■ Blue.



**Ref.: 4200**

F ... C ... S .. I ..

**NEOPRENE BACK SUPPORT**

SIZES	ONE SIZE
<p>FRONT HEIGHT 17 cm</p>	<p>BACK HEIGHT 24 cm</p>
<p>PERIMETER RANGE</p>	<p>65-105 cm</p>
<p>POSSIBILITY TO CUSTOMIZE</p>	

**Characteristics:**

Made from two types of material, the front in astrakhan neoprene of 2 mm and the back in normal neoprene of 3 mm. Adjustment fastener of 28 cm, which enables the adaptation to different anatomies. Neoprene retains body heat facilitating blood circulation, meanwhile relieving pain and favour the recovery and maintaining flexibility of the joint. It is light and comfortable for daily use.

**Indications:**

- Provides support during sporting activities.
- Prophylaxis in jobs with mechanical overload in the lumbosacral region.
- Non-specific lumbar pathologies and prevention of back injuries.

**Colour:** ■ Blue.



Ref.: 4304

F .. C .. S . I .

**NEOPRENE ELBOW SUPPORT**

SIZES	ONE SIZE
<p>HEIGHT 22 cm</p>	<p>POSSIBILITY TO CUSTOMIZE</p>

**Characteristics:**

The one size elbow support allows for tension control by means of adjustable bands that favour a perfect adaptation to the elbow joint. The joint area is perforated to facilitate transpiration. Made from 2 mm astrakhan neoprene.

**Indications:**

- Prevention of sporting injuries.

**Colour:** Blue.



Ref.: 4600

F . C .. S . I .

**NEOPRENE WRIST SUPPORT**

SIZES	ONE SIZE
	<p>POSSIBILITY TO CUSTOMIZE</p>

**Characteristics:**

3 mm neoprene wrist support with interior elastic strap to facilitate the adaptation by the patients themselves.

**Indications:**

- Prevention of wrist injuries.

**Colour:** Blue.



Ref.: 4302

F . C .. S . I .

**NEOPRENE EPICONDYLITIS ARMBAND**

SIZES	ONE SIZE
	<p>POSSIBILITY TO CUSTOMIZE</p>

**Characteristics:**

3 mm neoprene band reinforced with Velcro strap and two adjustable cushions in plastazote.

**Indications:**

- Prevention of sporting and workrelated injuries.
- Epicondylitis (tennis elbow).
- Epitrocleitis. (golfer's elbow).

**Colour:** Blue.



Ref.: 4603

F . C .. S . I .

**NEOPRENE WRIST SUPPORT BANDAGE**

SIZES	ONE SIZE
	<p>POSSIBILITY TO CUSTOMIZE</p>

**Characteristics:**

2 mm neoprene wrist support bandage, special for bandaging, that allows use on both the right and left hand.

**Indications:**

- Slight instabilities.
- Prevention in sports.
- Work-related prevention when carrying out repetitive movements of the wrist.

**Colour:** Blue.



Ref.: 4607

F . C .. S . I .

**NEOPRENE THUMB WRIST SUPPORT BANDAGE**

SIZES	ONE SIZE
	<p>POSSIBILITY TO CUSTOMIZE</p>

**Characteristics:**

Same characteristics as 4603, but includes thumb tube in the thumb area, which provides a light containment and thermal support in the trapeziummetacarpal joint, with 2 mm neoprene.

**Colour:** Blue.



**ORLIMAN**

# Advertising Material

## EXHIBITORS

### Thermomed®



Ref.: EXP-NE-GRA (Large)

200 x 70 cm

### Sofy-Plant® Gel

Podology



Ref.: EXP-SG

Units: 60  
50 x 32 cm

### Sofy-Plant® Gel

Podology



Ref.: EXP-Gel-Cartón

Units: 36  
67 x 34 cm

### Multi-Product Exhibitor



Ref.: EXP-MP

Units: 30-40  
180 x 52 cm

### Orliman® FeetPad

Technical Socks



Ref.: EXP-OV

Units: 12  
39 x 25 x 17 cm

### Multi-Product Exhibitor



Ref.: EXP-GEN

Units: 36  
180 x 33 cm

### Orliman® Biontech

Insoles



Ref.: EXP-BION

Units: 8  
32 x 45 cm

# Advertising Material

## EXHIBITORS

### Epitec® Fix

Epicondylitis Armband



Ref.: EXP-E21-Cartón

Units: 10  
50 x 20 cm

### Thermo-med One Size Line



Ref.: EXP-ONE-Cartón

Units: 14  
48 x 50 x 30 cm

### Elastic Line



Ref.: EXP-ORL-ELASTIC

Units: 21  
46 x 20 x 38 cm

### Sofy-Plant® Gel

Podology



Ref.: EXP-SF/SGN

Units: 18-20  
24 x 26 x 32 cm

### Hallux-Valgus



Ref.: EXP-HV33

Units: 10  
18 x 24 x 32 cm

### Pad-Fix

Patellar knee band



Ref.: EXP-SP110

Units: 10  
13 x 22 x 17 cm

### Orliman® FeetPad

Insoles



Ref.: EXP-PLCP

Units: 10  
30 x 20 x 20 cm

### Sofy-Plant® Gel

Podology



Ref.: EXP-SF-UNI

Units: 10  
30 x 20 x 20 cm  
(For any reference of Sofy-Plant® Gel)

### Conforgel

Mini-plantar bands



Ref.: EXP-G204-Cartón

Units: 10  
20 x 30 x 18 cm



# Advertising Material

## CATALOGUES



### ■ Catalogue

Ref.: Cat-EXT  
29,7 x 21 cm



### ■ Prescription Book

(Only spanish print version)  
Ref.: Cat-RECE  
22 x 26 cm



### ■ Pathology book

Ref.: Cat-LPI  
15 x 21 cm



## BROCHURES



### ■ Most represented products

Ref.: Cat-TRIF  
11 x 21 cm

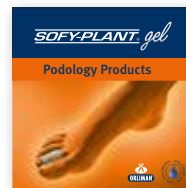

### ■ Sofy-Plant® gel

Ref.: Díptico-DPGG  
16 x 16 cm

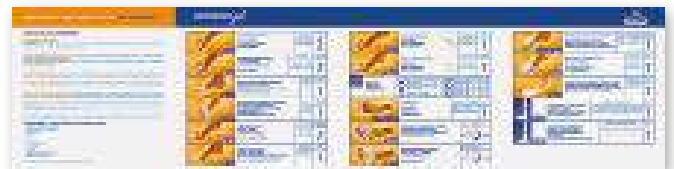

### ■ Orliman® Compression catalogue

Ref.: CAT/OVEX  
29,7 x 21 cm



### ■ Orliman® One Plus catalogue

Ref.: CAT-OPI  
29,7 x 21 cm



### ■ Orliman® Prosthesis catalogue

Ref.: Cat-PRTI  
29,7 x 21 cm



# Advertising Material



**Display**

Ref.: DISPLAYS-LNES  
100 x 60 cm



**Catalogue Sport**

Ref.: CAT/OSIF  
29,7 x 21 cm



**Sports Guide**

(Only spanish print version/  
available english digital pdf)  
Ref.: CAT-GDIN  
10 x 21 cm



**Sport Pathology Guide**

(Only spanish print version/  
available english digital pdf)  
Ref.: CAT#IDES  
29,7 x 21 cm



**Display**

Ref.: DISPLAYS-OREN  
47 x 148 cm



**Exhibitor**

Ref.: EXP-OS-EX#PEQ  
53 x 30 cm  
Units: 20



**Exhibitor**

Ref.: EXP-OS-EX#GRA  
160 x 60 cm  
Units: 40

# Advertising Material

**FIXQUICK** POWERED BY  
BOA FIT SYSTEM



**FIXQUICK Catalogue**

Ref.: Cat#BOAI  
28 x 21 cm



**FIXQUICK Exhibitor**

Ref.: EXPFQP  
40 x 27 cm



**FIXQUICK Display Stand**

Ref.: Displays-BOAI  
20 x 30 cm



**Sitlive Catalogue**

Ref.: CAT-STI  
29,7 x 21 cm



Ref.: EXP-SIT-UNI  
150 x 50 x 50 cm

# Advertising Material

## THERA GO

Functional therapeutic orthotics range



**Thera Go® Catalogue**  
Ref.: CAT#TGO1  
26 x 21 cm



**Thera Go® Multi-product display**  
Ref.: EXP-THG#EXT  
150 x 40 cm  
Units: 22

**ORLIMAN** | *Maternity*



**Orliman® Maternity Catalogue**  
Ref.: CAT#OMT1  
20 x 20 cm



**Orliman® Maternity Multi-product display**  
Ref.: EXP-MTR#GR  
165 x 35,5 cm  
Units: 23



**Display with girdle**  
Ref.: DISPLAY#OMT  
150 x 30 cm

# Advertising Material



## Pediatric Catalogue

Ref.: CAT/OPEX  
27 x 21 cm



## Small Display

Ref.: DISPLAYS OPD  
12 x 18 cm (double-sided)



## Display

Ref.: DISPLAYS OPD 2  
50 x 70 cm



## Exhibitor

Ref.: EXP-PDT



## FeetPAD Catalogue

Ref.: CAT-FTI  
29,7 x 21 cm



## FeetPAD small display Stand

Ref.: EXP-FT/PQ  
40 x 20 cm



## FeetPAD foot gauge

Ref.: DISPLAYS/MFT



## FeetPAD large display Stand

Ref.: EXP-FT/GRA  
150 x 40 cm



# Advertising Material

## MERCHANDISING



Ref.: METROS-BODY



Ref.: METROS-UNI



Ref.: GONIOMETRO-UNI



Ref.: TORSIOMETRO-UNI



Ref.: PUBLI-VARIA-LOGO



Ref.: TALONARIOS-LIB2



Ref.: PUBLI-VARIA#USB



Ref.: BOLI-PLAS#UNI



Ref.: TALONARIOS-NOT



Ref.: PUBLI-VARIA-BN



Ref.: METROS#MCL

## DISPLAYS/TOTEMS



Life 8

Ref.: LIF8  
100 x 60 cm

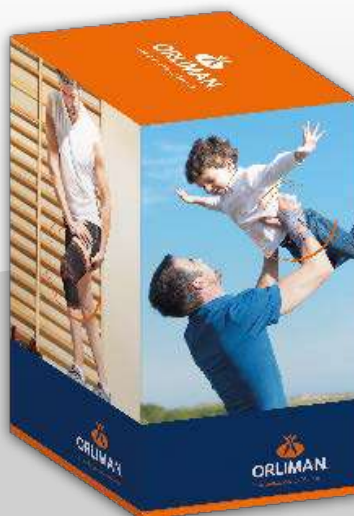

Life 6

Ref.: LIF6  
36 x 70 cm

